

Maritime Geothermal Ltd.

Installation Manual

NORDIC® models O-45-55-65

Revision 4.1

13-Feb-01

High Efficiency “Passive Cooling” Liquid Source Heat Pumps

Table of Contents

Heat Pump System Requirements	3	Duct Sizing Guide	12	Heat Exchanger Pressure Drop ..	19
Optimum Placement	5	Physical Dimensions (Vert.)....	14	CFM available	19
Plumbing the Heat Pump	5	Dimensions (Horiz.).....	15	Trouble Shooting Guide	20
Safety Controls	9	Electrical Requirements	16	Electrical Schematic	23
Starting the Heat Pump	11	Component Layout	17	Plenum Heater Connections.....	27
Maintenance	11	Performance Ratings	18	Warranty.....	28

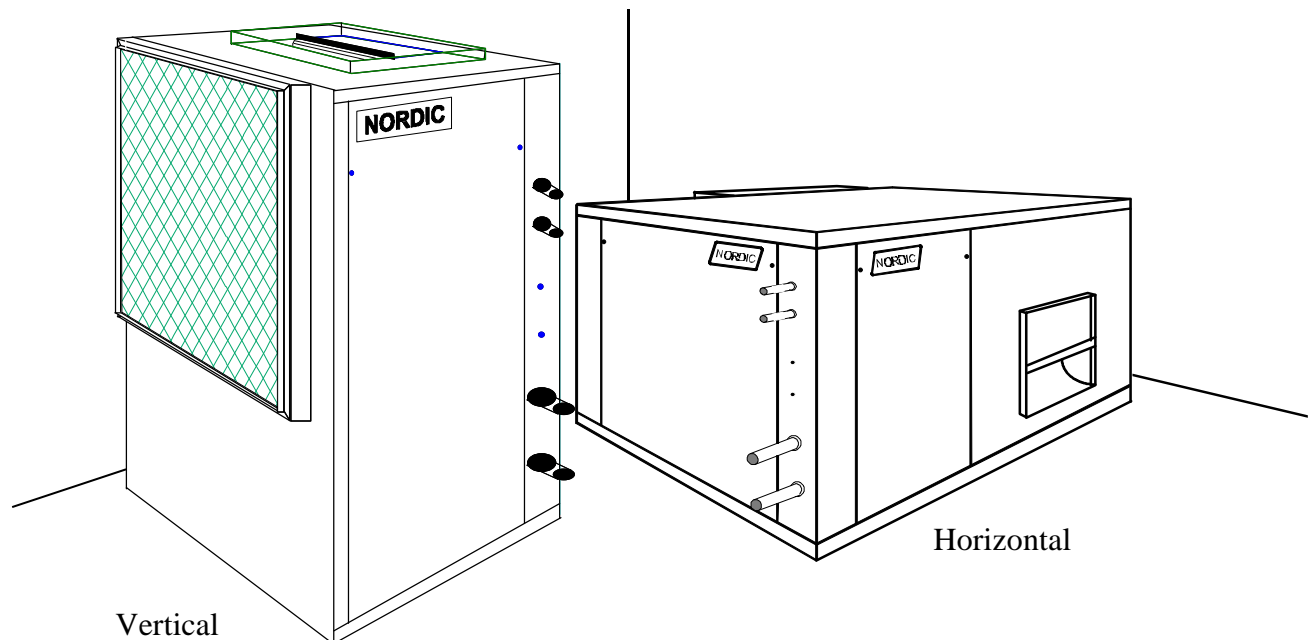

Specifically for Water Well Operation

Maritime Geothermal Ltd.
P.O. Box 2555
Petitcodiac, N.B. E4Z 6H4

Email: nordic@auracom.com
www.discribe.ca/nordic

A NORDIC® Groundwater Heat Pump System

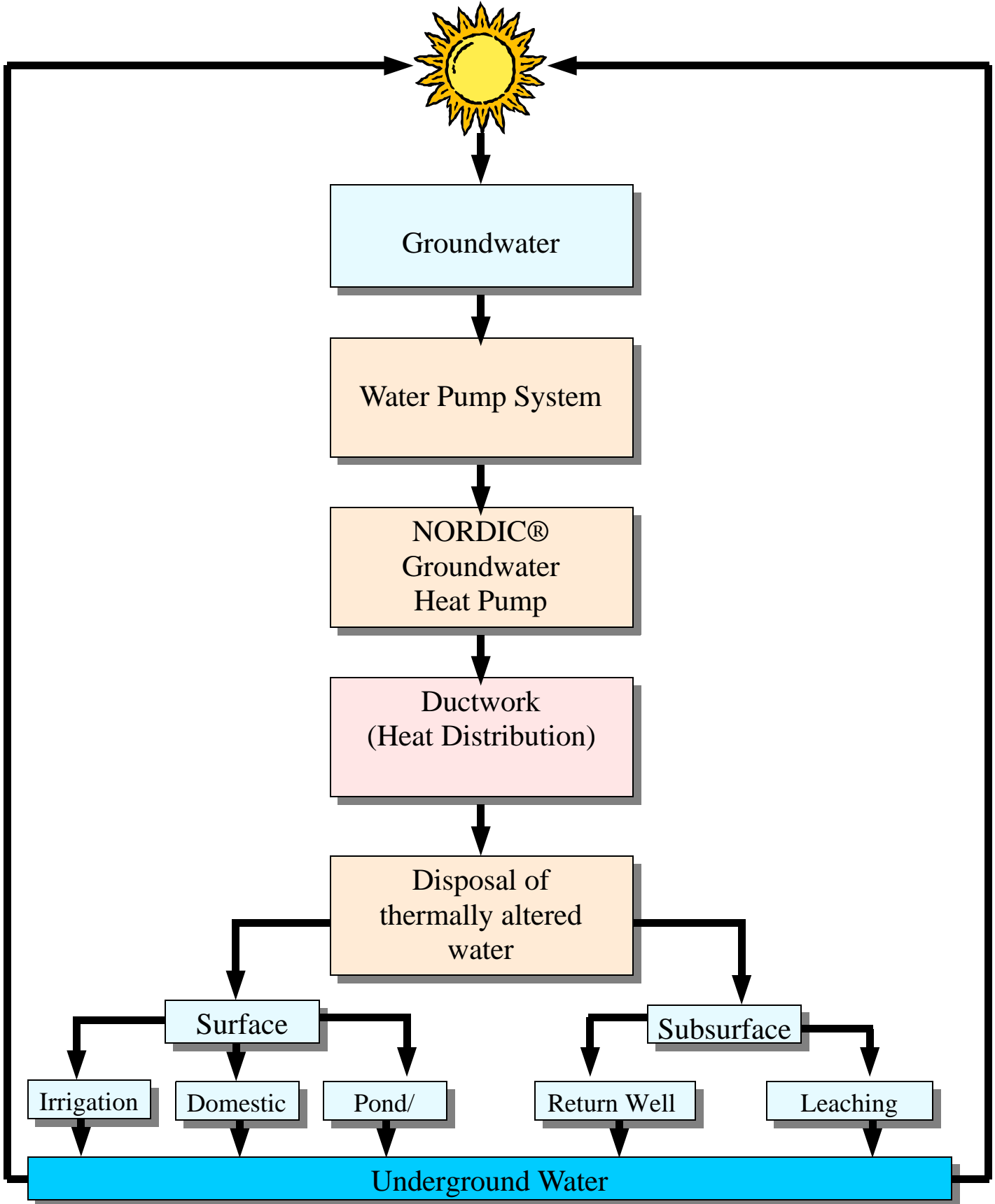

NORDIC® Heat Pump System Prerequisites

There are five specific parts or sub-systems to a groundwater heat pump installation: follows:

- | | |
|---|-------------------|
| 1. The source of energy (groundwater) | Water Well |
| 2. The method of supplying energy to the heat pump | Water Pump System |
| 3. Converting the energy to a useable form | Heat Pump |
| 4. Distributing the heat | Ductwork |
| 5. Returning the exhaust water to the earth for reheating | Water disposal |

Water Well Requirements

1. A DRILLED well of 5" diameter or larger.
2. Well casing properly sealed or grouted into rock.
3. Water flow preferably entering well at a depth of 75 ft. or more.
4. Temperature of well at least 40° F. (Normally 45 °F.)
5. Well must be able to supply requirements of BOTH heat pump and residence usage at the same time with maximum draw down from static level of 30 ft.

Water Requirements For Nordic® Heat Pumps

Model	Heat Pump	Home	Total
Nordic O-45	8 Igpm	3	11
Nordic O-55	10 Igpm	3	13
Nordic O-65	12 Igpm	3	15

Note: These are minimum water requirements based on an entering water temperature of 46° F.

Igpm = Imperial gallons per min.

Water Pump System

1. A submersible pump is generally required.
2. Must be able to pump the required water flow listed above at a minimum of 30 psig. at the dynamic pumping depth of your well.
3. Make sure you select the pump using the pump manufacturers pump chart.
4. Use a minimum of 30 gal. equivalent air bladder tank.

The Heat Pump

A heat pump with Btu output capable of heating the home in all winter weather conditions should be selected as

Duct Systems

A duct system capable of supplying the required air flow is of utmost importance.

- Generally allow 100 cfm for each floor grill.
- All leads to the grills should be 6" in diameter (28 sq.in. each).

Nordic® O-45 will heat up to 1800 sq.ft.
 Nordic® O-55 will heat up to 2700 sq.ft.
 Nordic® O-65 will heat up to 3500 sq.ft.
 Assuming at least R-20 walls and R-40 ceiling

- Your main hot air trunks should be at least 75% of the square surface area of leads being fed at any given point.
- Return air grills should have the same total square surface area as the total of your supply grills. (minimum)
 The square surface area of your return trunks should equal the square surface area of the grills being handled at any given point along the trunk.

Air Flow Available from each heat pump	
Nordic® O-45 models	1600 cfm
Nordic® O-55 models	1900 cfm
Nordic® O-65 models	2100 cfm

It is VERY IMPORTANT that all turns in both the supply trunks and the return trunks be made with TURNING RADII. Remember that air is a fluid and, just like water, it does not like to go around SHARP corner.

Nordic® O-45 could have up to 16 hot air grills.
 Nordic® O-55 could have up to 19 hot air grills.
 Nordic® O-65 could have up to 21 hot air grills.

NORDIC® O Series - Open Loop Disposal Methods

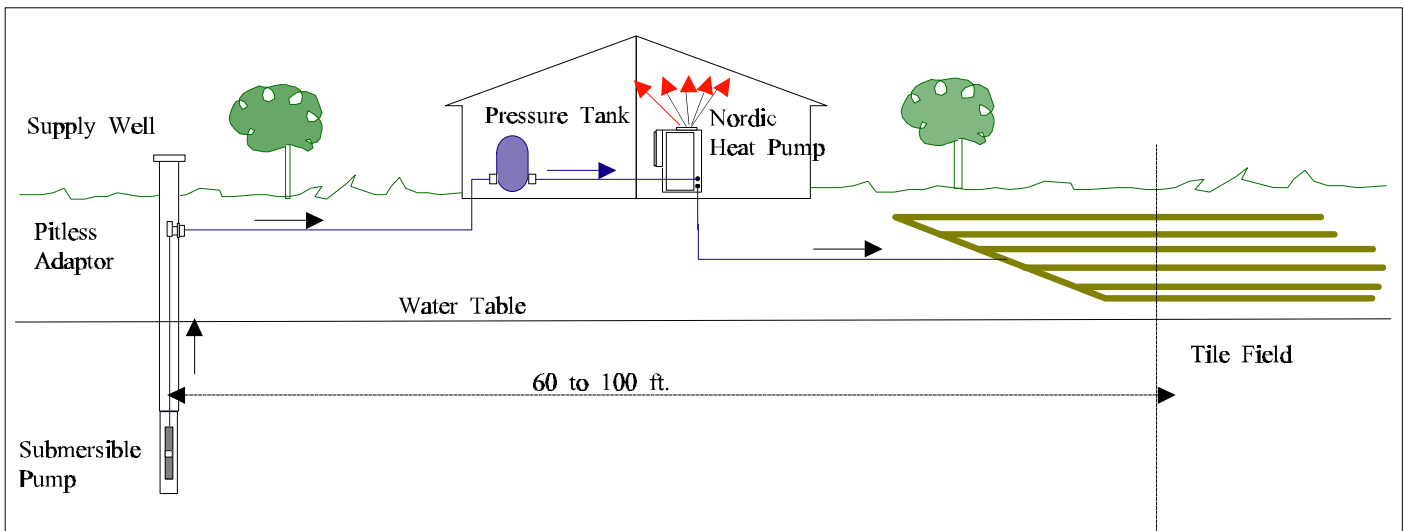
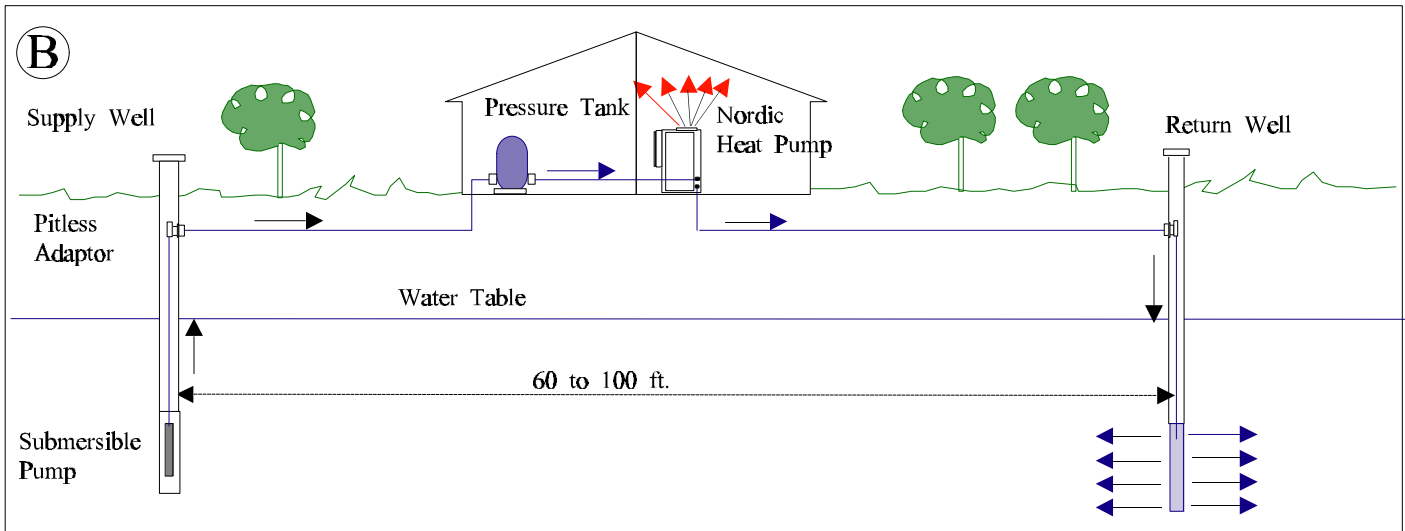
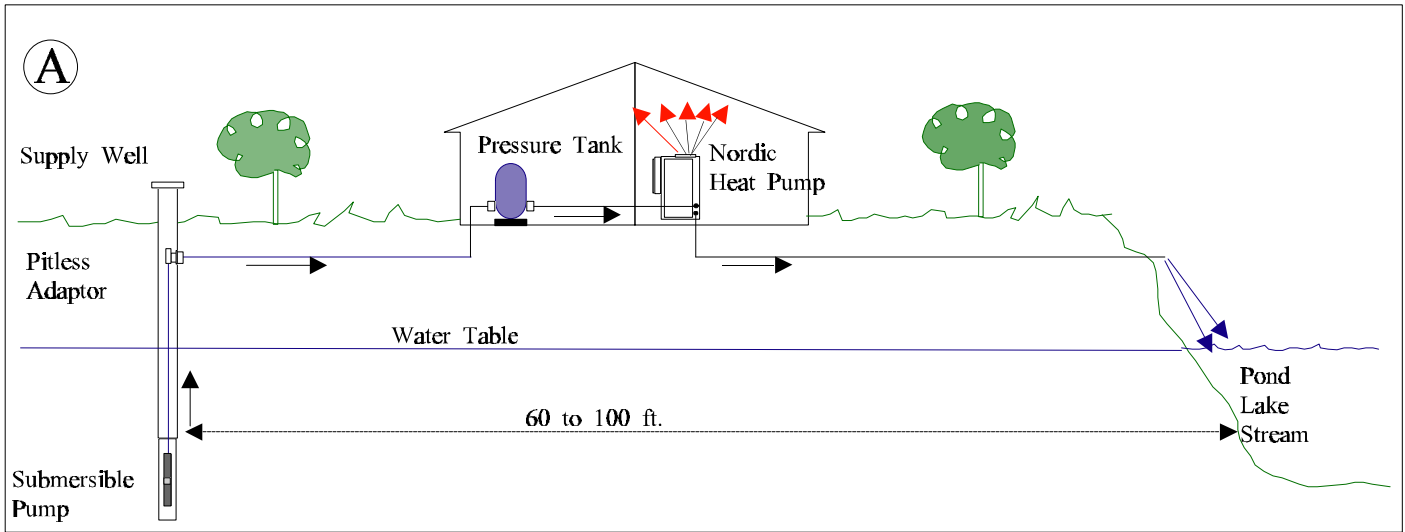

Discharge Water Methods

1. You do NOT necessarily have to have a return well.
2. 80% of our customers do one of the following with their return or waste water:
 - A. Run it into a drain or ditch.
 - B. Pond, river or stream.
 - C. Leaching field.

In most instances if you run the water right out on top of the ground it will soak back into the ground in less than 50 ft. of travel. If suitable care is taken to insure that the drain pipe runs downhill and the end of the pipe is protected by a bale of hay or spruce bows etc. the end of the pipe will not freeze. When snow comes it will usually cover the entire process much like a small spring.

The above information is intended to give the prospective user/purchaser some insight as to the general requirements for a successful application of the NORDIC® heat pump.

Unpacking

When the heat pump reaches it's destination it should be unpacked to determine if any damage has occurred during shipment. Any visible damage should be noted on the carrier's freight bill and a suitable claim filed at once.

The heat pump is well constructed and every effort has been made to insure that it will arrive intact, however it is in the customer's best interest to examine the unit thoroughly when it arrives.

Optimum Placement

The NORDIC heat pump has an air-filter rack which can be removed for easy entry through a doorway or to facilitate moving the unit with a furniture cart. Simply remove the two screws which hold the end cap in place, slide the cap off and push the rack back off it's rails. When the heat pump is in place the filter rack can be reinstalled with the removable end (where the filter is removed) facing the direction that allows easiest access for changing the filter.

To achieve the greatest efficiency, the heat pump should be centrally located in the home with respect to the conditioned space. This design provides the utmost in economy and comfort and usually can be accomplished in harmony with the design of the home. A heating system cannot be expected to produce an even warmth throughout the household when it is located at one end of the structure and the warm air is transmitted with uninsulated metal ductwork.

If possible the three main service doors should remain clear of obstruction for a distance of (2) two ft. so that

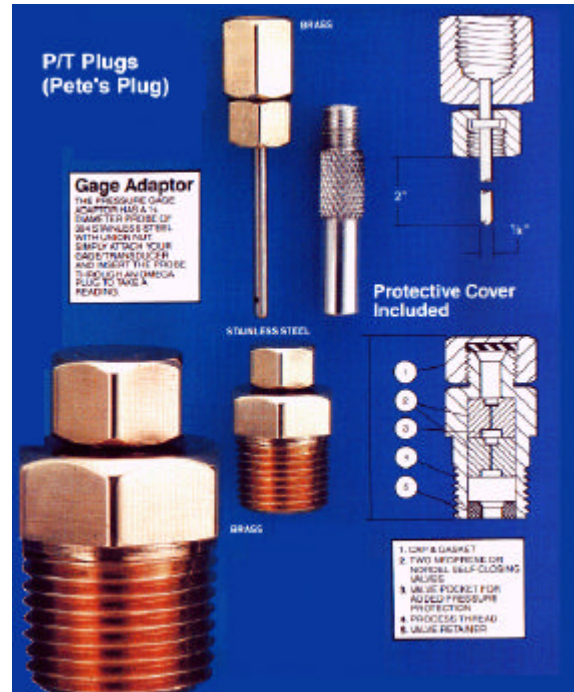

Typical P/T – “Pete’s” Plug & Thermometer Stems

servicing and general maintenance can be carried out with a minimum of difficulty. Raising the heat pump off the floor a few inches is generally a good practice since this will prevent unnecessary rusting of the bottom panel of the unit.

We recommend that the heat pump be placed on a piece of 2" Styrofoam covered with 1/4" plywood. The Styrofoam will smooth out any irregularities in the cement floor while the plywood will distribute the weight of the NORDIC® unit evenly over the Styrofoam. This process will also deaden the compressor noise emitted from the bottom of the cabinet.

As an alternative, several pieces of 2"x 4" lumber can be placed under the unit running from the electrical connection side to the filter rack side of the heat pump. Laying the 2"x 4"s in this manner will give the best support since they will be at right angles with the internal steel compressor and heat exchanger support.

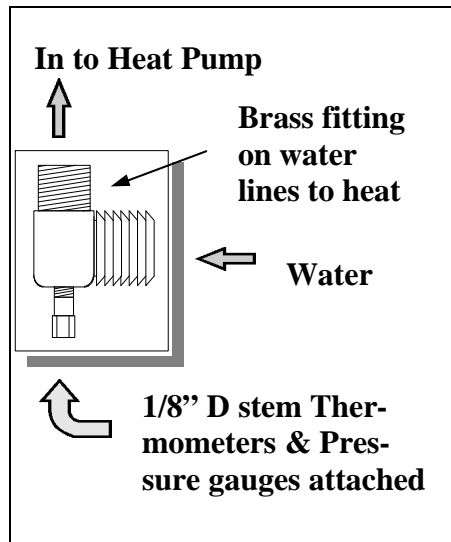

Plumbing the Heat Pump

The NORDIC heat pump must be supplied with an adequate water supply, since in essence, water is the fuel for the unit. It is imperative that the flow requirements listed in the engineering section be closely adhered to.

Maritime Geothermal Ltd. recommends the installation of a water flow meter on the discharge line so that the exact amount of water flowing can be

NORDIC® O- Series Typical Plumbing & Ductwork

Typical Piping and Plenum Arrangement for Water Well Operation

Cold Air Return

Hot Air Out

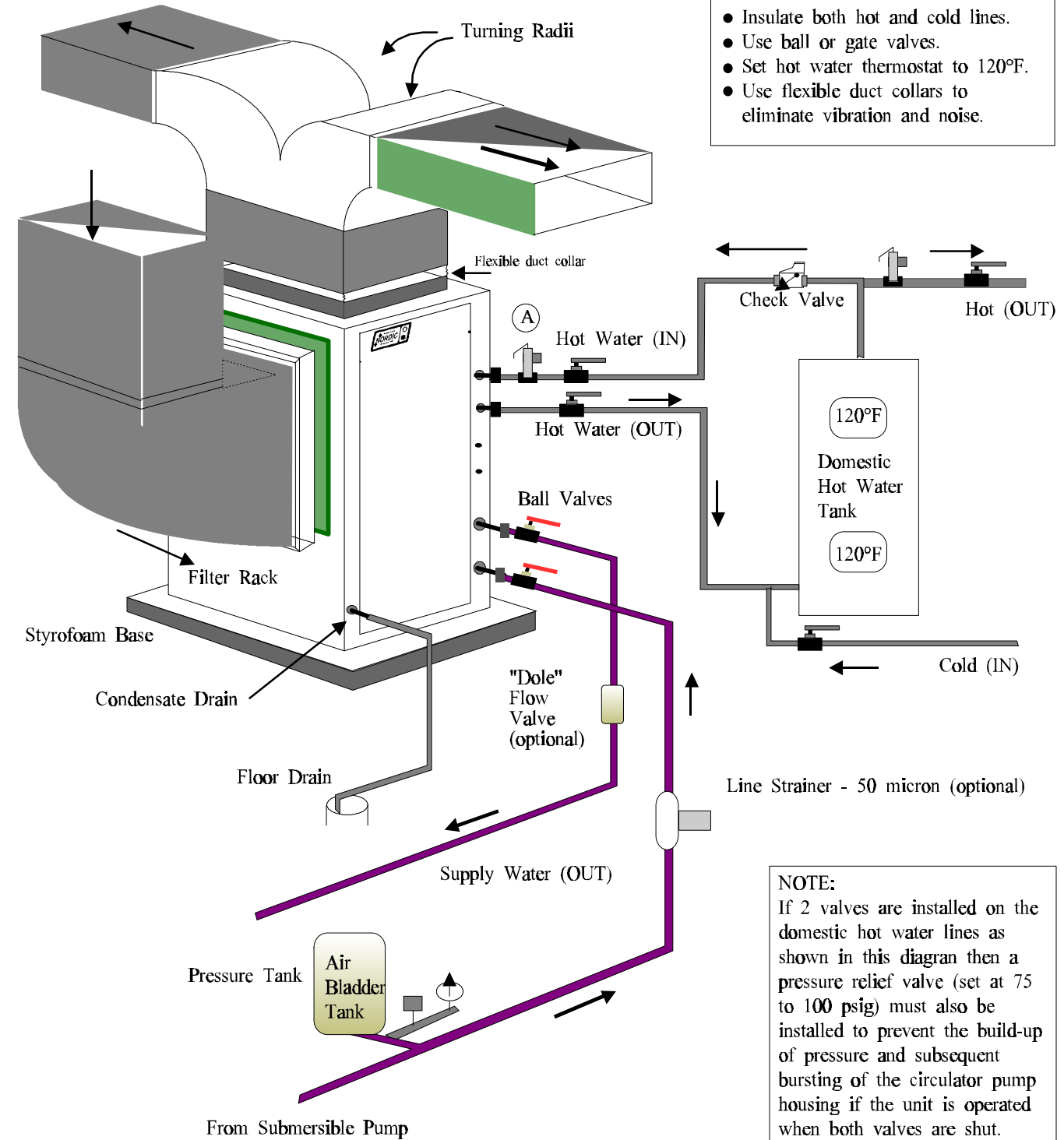

NORDIC® O-45-55-65

- Hot water lines are 1/2" copper.
- Cold lines 3/4" to 1"
- Insulate both hot and cold lines.
- Use ball or gate valves.
- Set hot water thermostat to 120°F.
- Use flexible duct collars to eliminate vibration and noise.

NOTE:
 If 2 valves are installed on the domestic hot water lines as shown in this diagram then a pressure relief valve (set at 75 to 100 psig) must also be installed to prevent the build-up of pressure and subsequent bursting of the circulator pump housing if the unit is operated when both valves are shut. See point marked "A" above.

determined at a glance.

Plumbing lines, both supply and discharge, must be of adequate size to handle the water flow necessary for the heat pump. For distances less than 40 ft. from the pressure tank, 3/4" copper or plastic lines should be run while for longer distances we recommend that 1" plastic or copper lines should be run to the heat exchanger. Similarly, a 1" line should be run from the discharge pipe to the method of disposal.

Ideally there will be water flow available in excess of the requirement of the heat pump. In such a situation the proper pump can be selected to maintain a pressure of 30 to 40 psig. on the lines when the heat pump is operating. However in some cases a well can supply a heat pump only if the minimum requirement for water is used.

Water flow to the heat pump can be controlled very accurately by the installation of a reverse action pressure valve in the discharge line of the unit. Another method of regulating the flow is by the use of a "DOLE" valve. This valve will automatically control the amount of water flowing through it by varying the diameter of a flexible rubber orifice through which the water passes. If either of such valves is needed they can be supplied and installed by your dealer.

All water line valves on both the supply and discharge lines should be either BALL or GATE valves since a GLOBE valve will create too much restriction across the line possibly causing the heat pump to trip out on it's low pressure safety cutout control as a result of insufficient water flow.

Install a P/T (*Pete's Plug*) plug on the Water (IN) and Water (OUT) lines just outside the heat pump so that it is easy to record the water in and out temperatures and pressures accurately. (See Diagram on Page 5)

Exposed water lines will have a tendency to sweat when the heat pump is in operation, therefore it is recommended that both the water supply and discharge lines be insulated with suitable insulation.

Hot Water Connections

Connection to the hot water generator feature of the heat pump is accomplished by teeing into an electric or oil fired hot water tank with a capacity of 40 gal. minimum. A typical piping diagram is shown elsewhere in this manual. Be sure to note the position of the check valve and the direction of water flow.

One should be sure the tank is filled with water and is under pressure before activating the heat pump. Slightly loosen the copper union on the hot water discharge pipe to allow air to escape from the system before the unit is started. This step will make certain that the water circulator is flooded with water when it is started.

Since the pump is water lubricated, damage will occur to the pump if it is run dry for even a short period.

The union on the discharge water line may have to be purged of air several times before good circulation is obtained. A hand placed several feet down the line will sense when the water is flowing.

The thermostats on the hot water tank should be set to 120°F. since the heat pump has an internal thermostat set at a low of 130°F. By setting the tank thermostats as described, the heat pump will try to keep the tank above the cut-in point

of the electric element settings thus generating hot water from the heat pump only. During summer, or periods of high demand, the electric elements will energize to help make hot water.

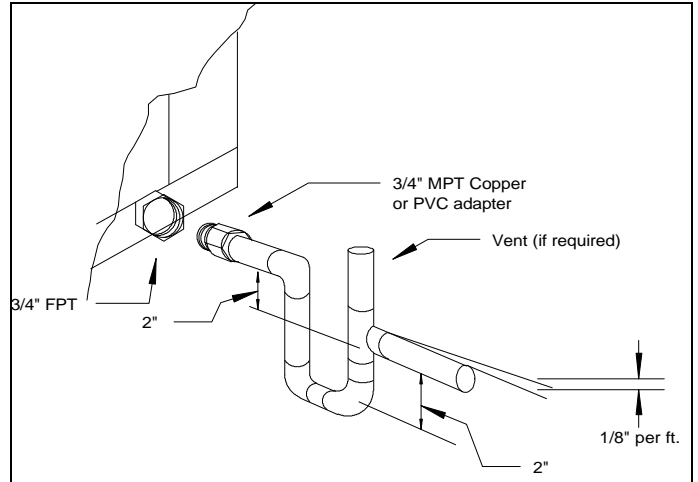

Typical Condensate Drain connection

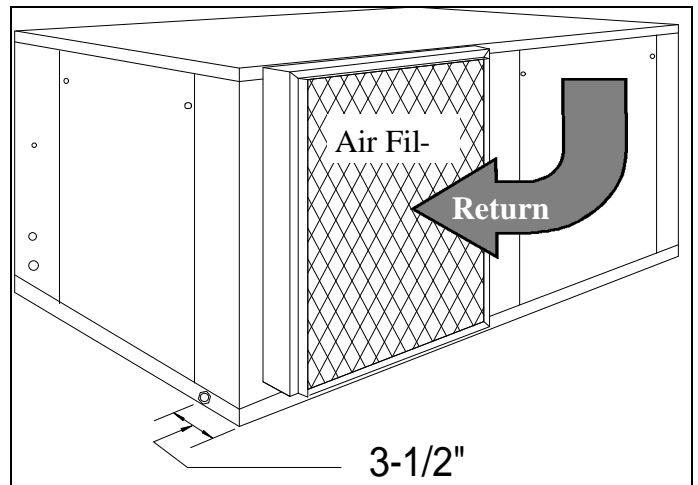

Condensate Drain location

NOTE: If (2) shut-off valves are located on the hot water lines as shown in the diagram, be sure that the valves are open when the heat pump is operating. If both valves are closed when the heat pump is operating, water will expand in the hot water heat exchanger and could cause damage to the hot water circulator pump.

Condensate Drain

You will notice in the piping diagram that there is a small drain pipe to the left of the front door. This drain allows the condensed water vapor which forms during the air-conditioning cycle to escape to a suitable area of your selection. On a very humid day there could be as much as 25 gallons of water formed. Care should be taken in the spring to insure that this pipe is not plugged with dust that has collected

Maritime Geothermal Ltd.		Revision 3.3	Desuperheater Piping
Water-to-Air Heat Pumps		Models: O-45-55-65	Style: Horizontal
Date: 13-Feb-01	Drawn By: G. Kaye	Title: Top & Bottom Access Port Tanks	

To domestic hot water system

Hot Water (out)

out

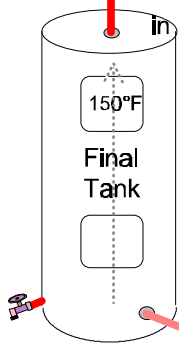

150°F

Final Tank

in

out

out

↓

↓

↓

↓

↓

↓

out

↓

↓

↓

↓

out

↓

↓

↓

↓

out

↓

↓

↓

↓

out

↓

↓

↓

↓

out

↓

↓

↓

↓

out

↓

↓

↓

↓

out

↓

↓

↓

↓

out

↓

↓

↓

↓

out

↓

↓

↓

↓

out

↓

↓

↓

↓

out

↓

↓

↓

↓

out

↓

↓

↓

↓

out

↓

↓

↓

↓

Cold Supply (IN)

Check Valve

Desuperheater Lines from HP

Return Air

Supply Air

5/8" OD Hot Water Lines
Insulate with 3/8" wall
armaflex insulation

O series Horizontal HP

To return well, pond etc.
or back to groundloop.

From supply well, pond etc.
or groundloop.

An alternate to the single domestic hot water tank setup is the design shown at left. This design maximizes your benefit from the heat pump desuperheater by allowing more storage and also insures that the water in the final tank has not been mixed with cold water thus reducing the output temperature.

The heat pump shown above is a horizontal unit although the two tank technique is applicable to both the vertical and horizontal models.

during the winter since the water formed will overflow into the bottom of the heat pump.

Water Disposal Methods

Water disposal methods vary from area to area however some consideration should be made to prevent the cooled discharge water from immediately coming in contact with the supply source. Generally speaking, returning water to a second well, pond lake or stream is acceptable while returning water to the same well will usually cool the water so much that the heat pump will shut off on it's low pressure / temperature safety control.

A return well should be a minimum of 80 ft. from the supply well for residential applications. The water returned to the well will not be necessarily be pumped into the same aquifer, depending on underground conditions, but the return well does have to be able to supply the same quantity of water as the amount you wish to recharge into it.

If the static level (level when not being pumped) of a well is high (10 to 20 ft. from the surface) it may be necessary to place a well cap on the well to keep the return water from flowing out the top of the well. This cap is commonly required since a certain amount of pressure is needed to force the return water back down the well if the static level is high.

Return wells are not always the answer and to some it may be more satisfactory to pump the water to a pond or away into the woods.

Water recharged naturally through percolation into the soil is an alternative to a recharge well. The water discharged will generally soak into the ground within a distance of 50 to 100 ft. If care is taken to make sure the end of the pipe does not freeze then this method of disposal works well.

Safety Controls

The NORDIC heat pump has two built in safety controls which are designed to protect the unit from situations which could damage it.

A. LOW PRESSURE / TEMPERATURE CONTROL

The low refrigerant pressure / temperature control is designed to shut the unit down if the refrigerant evaporating pressure becomes too low thus risking the danger of freezing conditions in the evaporator.

There are only (4) reasons why this control would activate and they are:

- 1. Low water flow. (See requirements for each model.
- 2. Low water temperature. (Below 40 °F.)
- 3. Dirty or fouled heat exchanger.
- 4. Low refrigerant charge.

B. HIGH PRESSURE CONTROL

The second safety control is a high pressure safety limit which monitors compressor discharge pressure. This device will not normally trip unless there is an interruption in air flow. Such a situation could occur if the blower motor or fan belt failed or if the heat pump had an extremely dirty air filter.

If either of these controls trips it will activate a **LOCK-OUT RELAY** which prevents the unit from restarting until power to the control circuit is broken (by turning the thermostat to the **OFF** position and then back on again) or the electrical supply to the unit is broken by opening the heat pump breaker and then closing it again. If one of these controls trips there is a serious problem with the system and it must be rectified if the unit is to maintain good service.

NOTE: Under no circumstances should the heat pump lock-out relay be reset more than twice in an hour. If the the heat pump is shutting off because of LOW or NO water flow then repeated resetting of the unit could cause the heat exchanger to freeze and rupture destroying the heat pump.

Electrical Nordic® (O) Models

The NORDIC unit is supplied with an opening for 3/4" conduit nipple on the right blank side of the unit. An additional knockout (1/2") is provided to facilitate connection of a plenum heater blower control wire if required. Above this is another 3/8" hole for the thermostat wire. A wiring diagram is located inside the electrical box cover for quick reference and although the connections to be made are quite simple, Maritime Geothermal Ltd. recommends that a properly qualified electrician be retained to make the connections and wire the thermostat.

The NORDIC unit comes supplied with a thermostat and connections are clearly marked on the control box. Using a 8-conductor (18 gauge) wire suitable for the job, connect the terminals in the heat pump electrical box to the corresponding terminals on the thermostat. An additional 4-conductor wire will be required for low voltage control of a NORDIC plenum heater if required.

Ductwork

Ductwork layout for a NORDIC® heat pump will differ from normal design in the number of leads and size of main trunks required. Air temperature leaving the heat pump is normally 95° to 105° F., much cooler than that of a conventional warm air furnace. To compensate for this, larger volumes of lower temperature air must be moved and consequently duct sizing must be able to accommodate the greater air flow without creating a higher static pressure or high velocity at the floor diffusers. Maritime Geothermal Ltd. recommends that the static pressure be kept below .2 inches of water total. Return ducts should ideally be placed in every room and be sized 50% larger than corresponding supplies. In some instances the number of floor diffusers will actually double when compared to the number that would normally be used for a warm air oil-fired furnace.

NOTE: See the duct sizing chart in the engineering section of this manual.

Maritime Geothermal Ltd.		Revision 3.3	Color: Caissie Grey
Hot Water Tank Connections		Models: O-45-55-65	Style: Horizontal
Date: 13-Feb-01	Drawn By: G. Kaye	Title: Top Access Port tank piping	

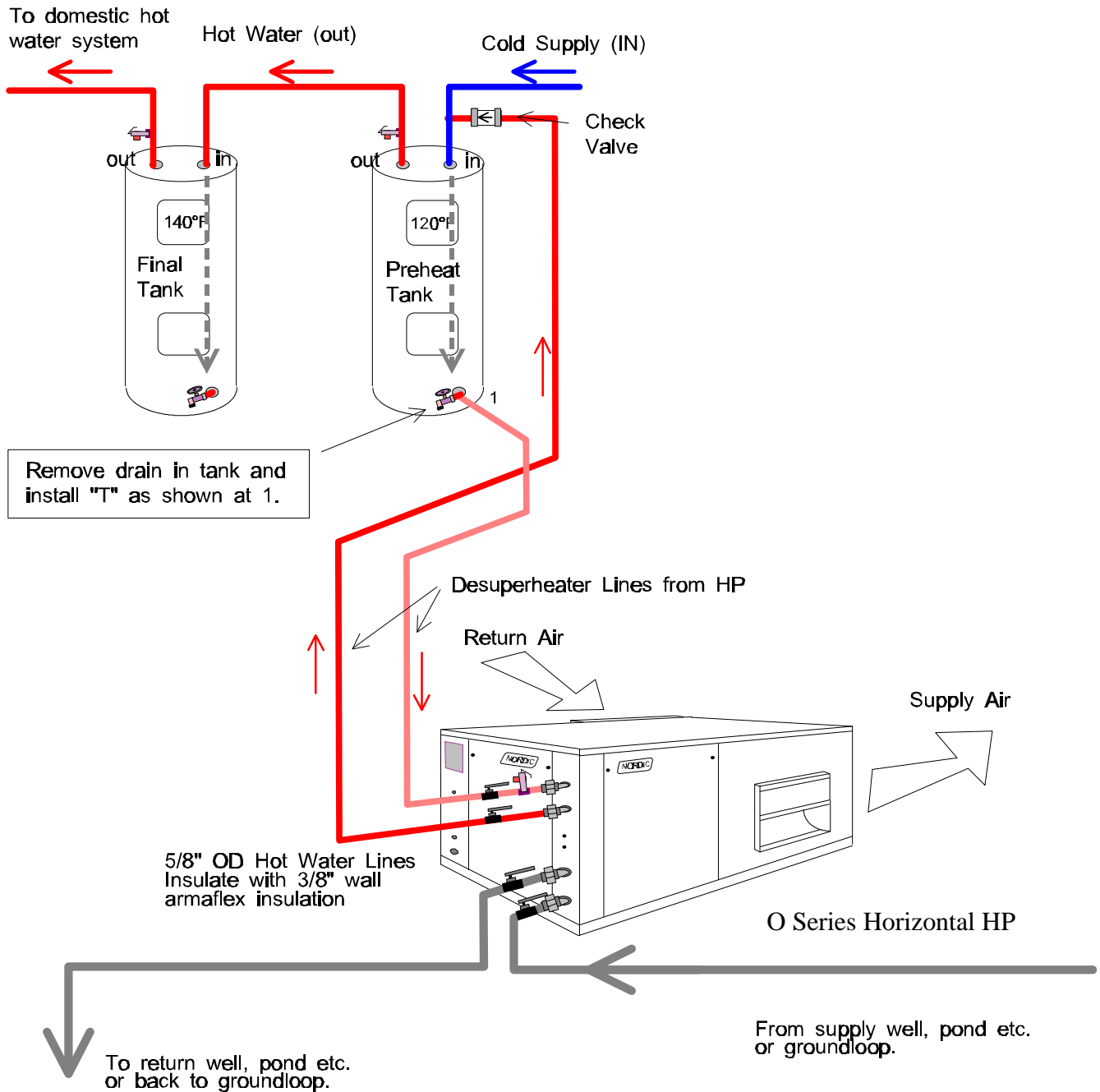

Diagram above shows a horizontal "O" series heat pump connected to a heat pump pre-heat tank with both the inlet and exit access ports at the top of the tank. Always observe the "HOT IN" and "HOT OUT" markings on the heat pump and the direction of the check valve when connecting your linesets.

Starting the Heat Pump

BEFORE starting the heat pump the following areas should be rechecked to assure proper operation.

1. Check all high voltage field wiring and electrical connections inside the control box for good connection.
2. Check all low voltage thermostat to make sure they are connected properly. Place thermostat HEAT-OFF-COOL switch in the OFF position.
3. Turn on the main power switch. Allow the power to remain ON without starting the unit for a period of 4 hours. Refrigerant migrates to the compressor oil when the compressor is unheated. A crankcase heater is standard equipment on your heat pump and it will warm the compressor, dispelling the liquid refrigerant. Compressor damage can occur if the heat pump has been brought in from a cold location and immediately started up.
4. Turn on the water supply and check all plumbing for leaks.
5. Check the hot water tank to be sure it is filled with water before energizing the circuit.

NOTE: In a low ambient air start-up the hot water tank should be energized for at least 4 hours before the heat pump is started. A combination of low air temperature and 45° F. water in the hot water tank can sometimes cause the unit to shut down on it's low pressure control. If this happens close ONE valve in the hot water circuit to temporarily shut off the flow to the hot water generator. Do not shut off both valves since water expanding in the hot water generator loop may cause damage to the circulator pump housing. When the home has come up to temperature open the valve for normal hot water operation. Slightly open the union on the hot water discharge pipe to make sure that all air is out of the system and the circulator pump is flooded with water.

6. Make sure the air filter is clean and in place.
7. Vacuum out any dust and debris that may have collected in the unit during installation. Check the condensate drain to be sure that it is free of obstruction.
8. Make sure the unit is sitting level so that condensate water will not overflow the catch pan.
9. Make sure the proper time-delay fuse has been installed in the fuse box.
10. Have the following tools on hand and know how to use them.
 - A refrigeration gauge set.
 - An electronic or other accurate thermometer
 - An amprobe.
 - A water flow meter.
11. Connect your refrigeration gauge set.
12. After the 4 hour warm-up period place the thermostat function switch in the HEAT position, turn up the thermostat. The compressor, blower and hot water circulator will start.

NOTE: If the unit is equipped with an electric TACO water valve the blower will start first followed by the compressor in 30 to 60 seconds. When the TACO water valve is fully open, an internal switch activates the compressor circuit.

13. Observe the readings on the high and low pressure

gauge set. When the home reaches a temperature of 65 to 70 °.F. the suction pressure (blue gauge) should be approximately 53 to 58 psig. while the head or discharge pressure (red gauge) should be in the area of 225 to 275 psig. Record this information on the warranty test card.

14. Using an electronic thermometer or other accurate thermometer, record the supply water temp. (IN) and the water temperature (OUT).

The outlet water temperature should be from 4° to 7° F. cooler than the inlet water temperature.

15. Record the supply water flow in gpm.

16. Record the return air temperature by drilling a small hole in the return air plenum approximately 2 ft. from the filter rack and inserting the thermometer's sensing device.

17. Similarly record the discharge air temp. There should be a rise across the air exchanger of from 25° to 35°F.

18. At the electrical disconnect switch place the amprobe jaws around the supply wires and record the current in each.

19. Place the thermostat function selector in the COOL position and turn down the stat to a temperature that will cause the air-conditioning to begin. When the thermostat selector switch is set in the COOL mode the water flow valve will be energized. The blower should start followed by the compressor. The outlet temperature will be approx. 10° to 20°.F. cooler than the return air temp.























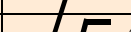
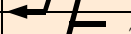
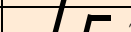





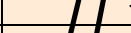

General Maintenance

As with any piece of equipment there will eventually be some maintenance to be done on the heat pump. Several areas will need attention and they are as follows:

1. Change the air filter when required.
2. Oil the blower motor once a year.
3. Clean the groundwater heat exchanger.
4. Inspect the blower belt for cracks & wear.
5. Insure the condensate drain is clean.

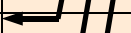
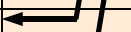
Reversible NORDIC® heat pumps are equipped with coaxial type heat exchangers. These heat exchangers are not manually cleanable however they can be cleaned with a sulfamic acid solution commonly marketed under the trade name "**Iron-Out**". If you suspect that the water being pumped through the unit is of a poor quality or you notice a decrease in performance after several years of use it may be necessary to have the liquid heat exchanger cleaned.

Maritime Geothermal recommends that a qualified serviceman be retained to carry out this procedure since the solution involved is highly corrosive.

Duct Sizing Guide									
Required CFM	Diameter in inches	Rectangular Equivalents						Return Air Diameter	Required CFM
37	5	2.25 x 10	3 x 8	3.5 x 6	4 x 5.5	5 x 5			37
63	5	2.25 x 10	3 x 8	3.5 x 6	4 x 5.5	5 x 5			63
100	6	3.25 x 10	4 x 8	5 x 6	5.5 x 5.5	6 x 6			100
152	7	3.25 x 14	4 x 11	5 x 8.5	6 x 7	6.5 x 6.5			152
212	8	4 x 15	5 x 12	6 x 10	7 x 8	8 x 8			212
226	8	4 x 15	5 x 12	6 x 10	7 x 8	8 x 8			226
277	9	5 x 15	6 x 12	7 x 10	8 x 9	8.5 x 8.5			277
304	9	5 x 15	6 x 12	7 x 10	8 x 9	8.5 x 8.5			304
393	10	6 x 15	7 x 13	8 x 11	9 x 10	9.5 x 9.5			393
411	12	7 x 18	8 x 16	9 x 14	10 x 12	11 x 11			411
655	12	7 x 18	8 x 16	9 x 14	10 x 12	11 x 11			655
680	14	8 x 22	9 x 19	10 x 17	11 x 15	12 x 14	13 x 13		680
995	14	8 x 22	9 x 19	10 x 17	11 x 15	12 x 14	13 x 13		995
1325	16	8 x 30	10 x 22	12 x 18	14 x 16	15 x 15			1325
1450	16	8 x 30	10 x 22	12 x 18	14 x 16	15 x 15			1450
1750	18	8 x 40	10 x 30	12 x 24	14 x 20	16 x 17	16.5 x 16.5		1750
2000	18	8 x 40	10 x 30	12 x 24	14 x 20	16 x 17	16.5 x 16.5		2000
2250	20	10 x 38	12 x 30	14 x 26	16 x 22	18 x 19	18.5 x 18.5		2250
2600	20	10 x 38	12 x 30	14 x 26	16 x 22	18 x 19	18.5 x 18.5		2600
2900	22	12 x 36	14 x 30	16 x 26	18 x 23	20 x 20			2900
3400	22	12 x 36	14 x 30	16 x 26	18 x 23	20 x 20			3400
3600	24	14 x 38	16 x 32	18 x 28	20 x 25	22 x 22			3600
4300	24	14 x 38	16 x 32	18 x 28	20 x 25	22 x 22			4300
5250	26	16 x 38	18 x 32	20 x 30	22 x 24	24 x 24			5250
6125	28	18 x 38	20 x 34	22 x 30	24 x 28	26 x 26			6125
6500	28	18 x 38	20 x 34	22 x 30	24 x 28	26 x 26			6500
7250	30	20 x 40	22 x 38	24 x 32	26 x 30	28 x 28			7250
7800	30	20 x 40	22 x 38	24 x 32	26 x 30	28 x 28			7800
8500	32	22 x 40	24 x 38	26 x 34	28 x 32	30 x 30			8500
9200	32	22 x 40	24 x 38	26 x 34	28 x 32	30 x 30			9200
9800	34	24 x 42	25 x 40	26 x 38	28 x 34	30 x 32	31 x 31		9800
10900	34	24 x 42	25 x 40	26 x 38	28 x 34	30 x 32	31 x 31		10900
		28 x 40	30 x 36	32 x 34	33 x 33				
		30 x 42	32 x 38	34 x 36	35 x 35				
		30 x 45	34 x 40	36 x 38	37 x 37				

NORDIC® Series O-45-55-65

[Redacted]

[Redacted]

[Redacted]

[Redacted]

[Redacted]

Engineering and Performance Data

[Redacted]

[Redacted]

[Redacted]

[Redacted]

[Redacted]

13-Feb-01

Maritime Geothermal Ltd.		Revision 2.3	Color: Caissie Grey
Water-to-Air Heat Pumps		Models: O-45-55-65	Style: Vertical
Date: 13-Feb-01	Drawn By: G. Kaye	Title: Cabinet & Piping Layout	

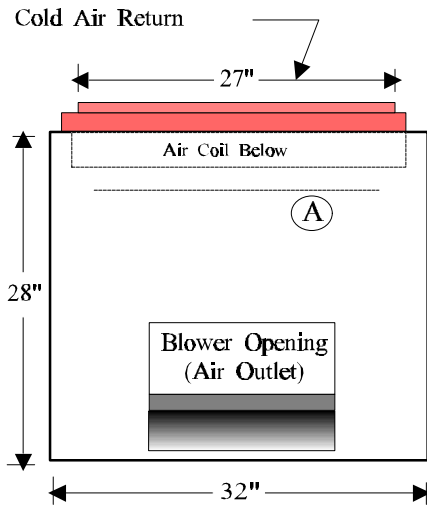

- Basic cabinet design is similar for all four NORDIC® models 45 55 65 & 75 series.
- Cold air return measures 27" wide x 30.5" high.
- Hot air plenum can be attached at any point on the top of the unit except within 6" of filter rack.
- See dotted line at left --- Point "A"
- Blower opening (outlet) shown is for a G-12 blower (models 55 65 & 75). A G-10 blower is used for models 35 and 45 with dimensions 11.5" x 13.5" centered similar to the G-12 unit shown

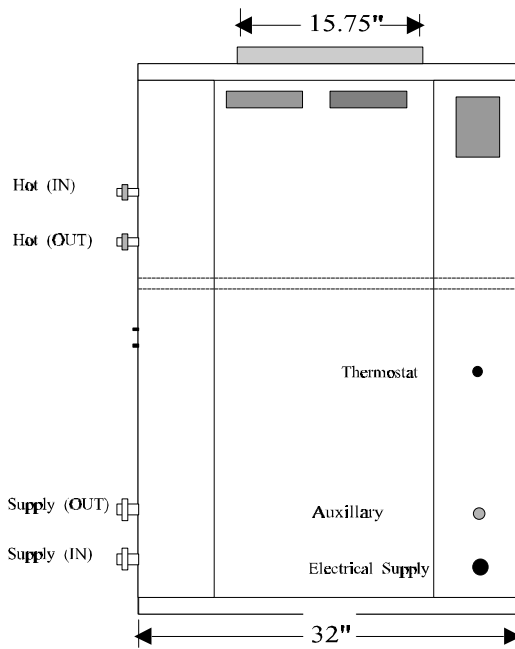

Right Side View

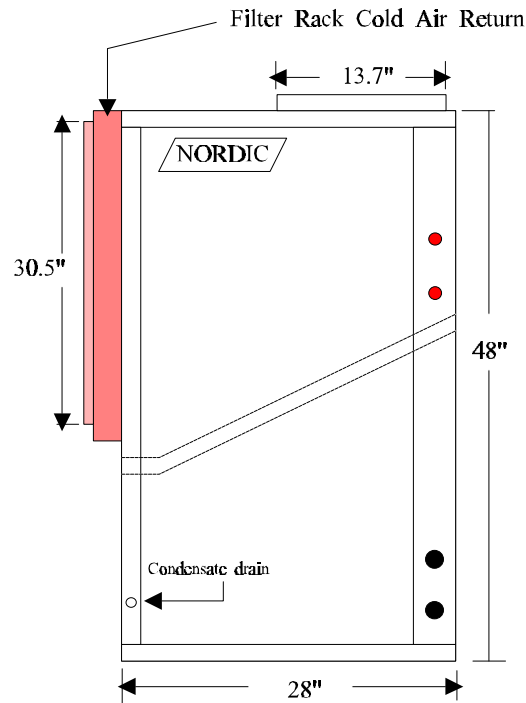

Front View

- Unit cabinet constructed of 20 gauge satin galvanized sheet metal. Reinforcing devices are placed at all high stress points.
- All components are easily accessible through three full length removable doors.
- Cabinet insulated with flame retardant accoustic insulation.



Maritime Geothermal Ltd.		Revision 2.3	Color: Caissie Grey
Water-to-Air Heat Pumps		Models: O-45-55-65	Style: Horizontal
Date: 13-Feb-01	Drawn By: G. Kaye	Title: Cabinet & Piping Layout	

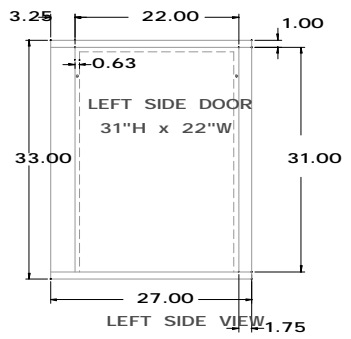
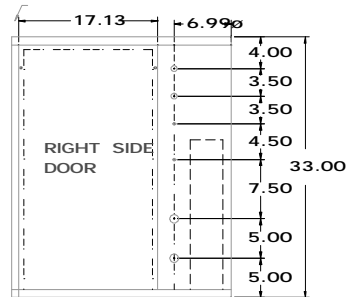
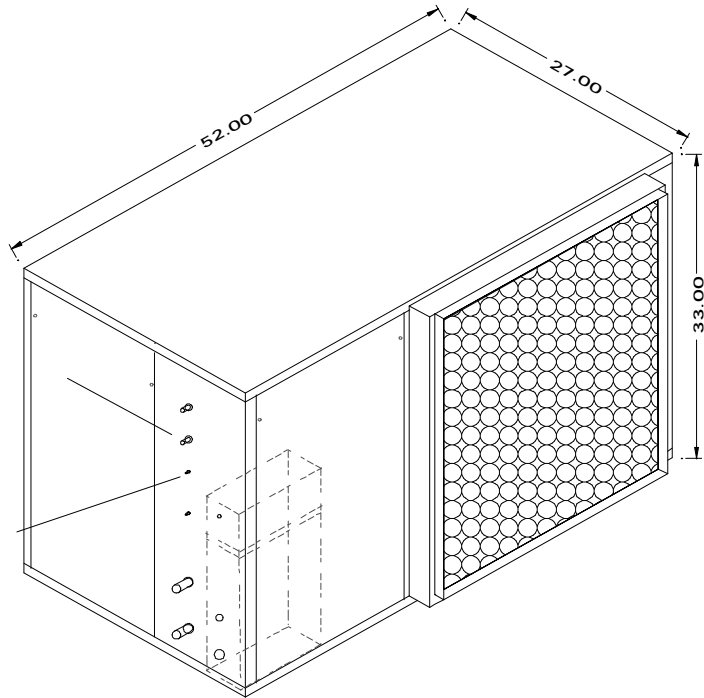
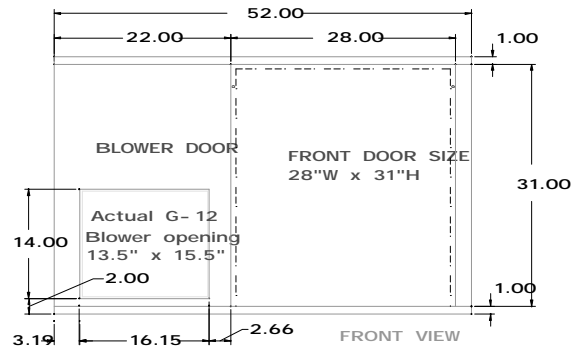
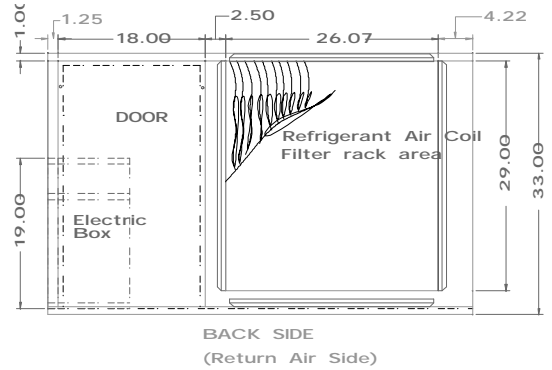
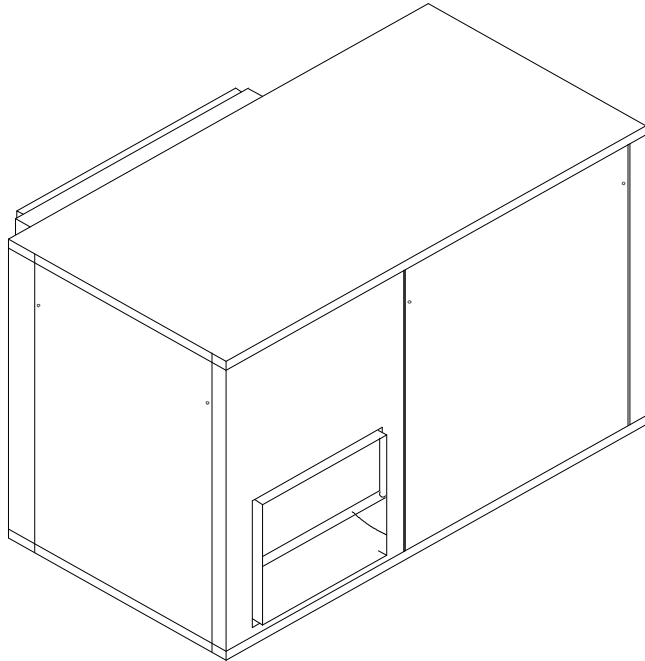

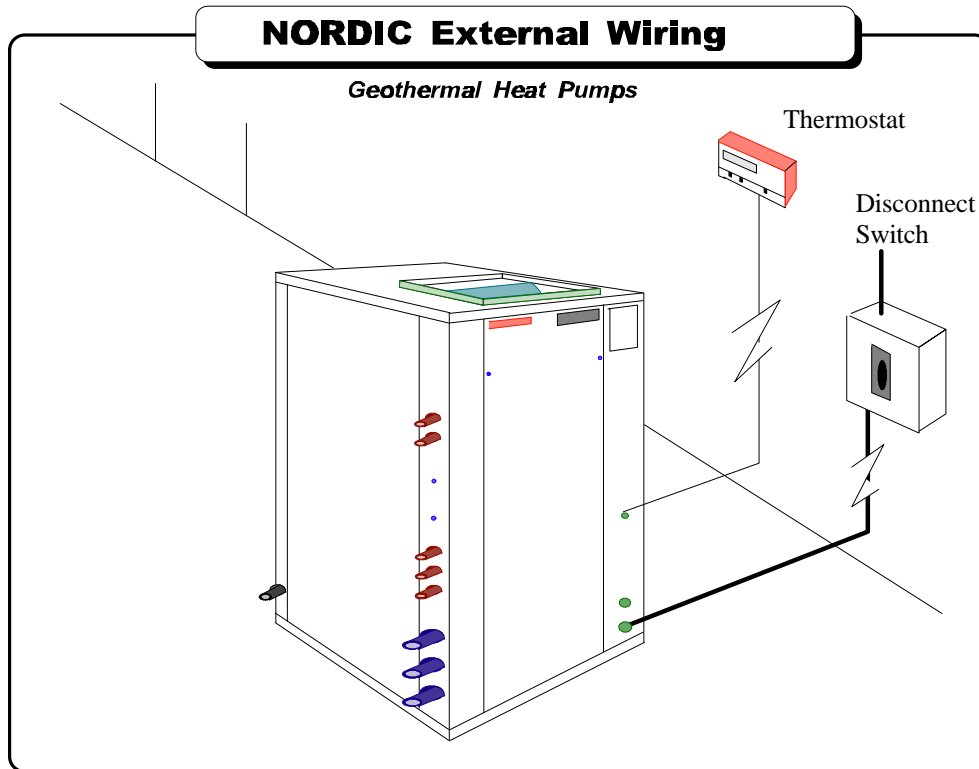

Electrical Supply and Thermostat Wire Sizes

Model	O-45	O-55	O-65
Nominal BTU output	40,000	50,000	60,000
Min. circuit ampacity	29	32	37
Minimum wire size	# 8-3	# 6-3	# 6-3
Max. Fuse Size	40	40	50
Max. breaker size	40	40	50
Thermostat wire size	# 18	# 18	# 18
Thermostat conductors	8	8	8

Domestic Hot Water Generator Specifications

Temperature (IN) °F.	Temp (OUT) °F.	Temperature Rise °F.	% of Total	O-45 (lgal/hr)	O-55 (lgal/hr)	O-65 (lgal/hr)
40	150	110	20	10	11.8	14.5
45	150	105	18	9.4	11.1	13.7
50	150	100	15	8.33	9.8	12.1
60	150	90	12	7.33	8.6	10.6
75	150	75	10	7.33	8.6	10.6
90	150	60	8	7.33	8.6	10.6
110	150	40	5	6.87	5.4	10

Maritime Geothermal Ltd. NORDIC® O - Series

Premium Features - Passive Cooling Series

- Return Air Filter
- Oversize high efficiency air coil.
- Belt drive blower with ball bearings.
- High efficiency ball bearing, PSC style motor.
- Galvanized drip tray.
- Sight glass (optional)
- Suction accumulator.
- Filter drier.
- Thermostatic expansion valve.

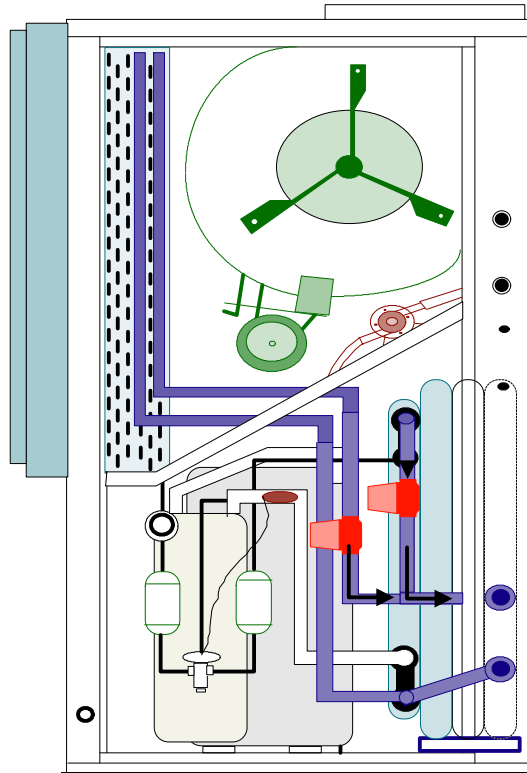

(Front) Plumbing side

- Hot Water (IN)
- Hot Water (OUT)
- Hot Water circulator
- High & Low access ports.
- Slow closing water valve.
- High Efficiency coaxial heat exchanger.
- Supply water (OUT)
- Supply water (IN)]
- Insulated water coil.
- High efficiency Tecumseh compressor

- Baked enamel cabinet with satin galvanized condensate tray and floor.
- Components accessible from three sides.
- Heavy duty electrical components.
- Hard start kit on all models.
- Blower motor field replaceable.

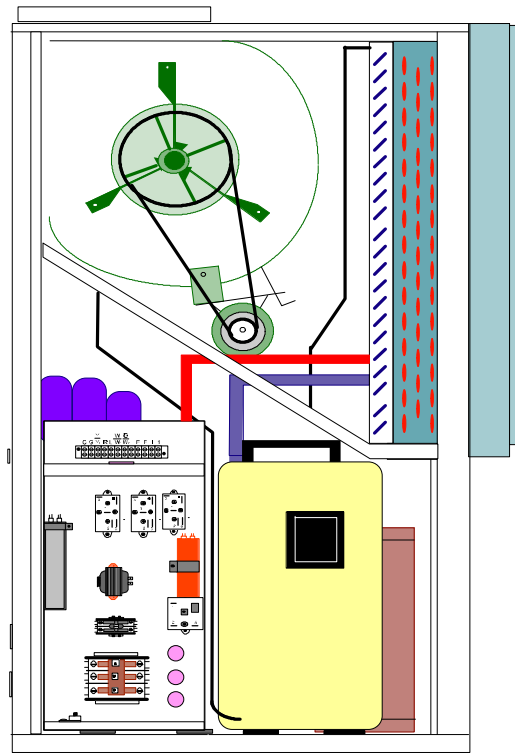

(Back) Electrical Box Side

- Remote reset lock-out relay system.
- Acoustically insulated cabinet.
- Cabinet spot welded together for superior strength.
- Removable and reversible filter rack.

Capacity Data Model O-45-HPCW (nominal 3 ton)

Heating

EWT	Igpm	Lpm	LWT	Diff	HAB	Pres Drop	EAT	LAT	Diff	Btu's Out	Comp Amps	Comp Watts	Blower Amps	Blower Watts	Total Watts	COP	CSA COP	Suct	Disc Pres
70	8	36.3	60.3	9.5	45550	5.88	69.8	106	36	58702	18.72	3543	6.64	439.3	3982	4.3	3.62	81.8	288
60	8	36.2	51.8	8.1	38887	5.88	69.8	100	30	51596	17.24	3231	6.41	436.9	3667	4.1	3.4	69.5	258
55	8	36.1	47.7	7.5	35960	5.88	69.8	98	28	47962	16.75	3104	6.66	461.8	3565	3.9	3.24	63.5	243
50	8	36.3	43	6.8	32646	5.88	70.2	96	26	44730	16.42	2972	6.49	441.8	3413	3.8	2.12	56.6	232
45	8	36.1	38.8	6.2	29652	5.88	70.2	94	24	40917	16.06	2860	6.86	483.8	3343	3.6	2.93	51.1	221
40	10	45	35.4	4.7	28097	8.83	70	93	23	38777	15.62	2762	6.16	446.6	3208	3.5	2.69	48.1	211

Cooling

EWT	Igpm	Lpm	LWT	Diff	Water Output	Pres Drop	EAT	LAT	Diff	Sens. cooling	Latent Cooling	Total Cooling	Comp. Amps	Comp Watts	Blower Amps	Blower Watts	Total Watts	EER	CSA EER
50	10	45.2	45.5	4.69	28125	5.38	80	67	13	19688	8753	28440	PASSIVE		6.52	444	444	64.0	16.0
50	8	36.2	44.9	5.27	25312	5.41	80	68	12	17719	7877	25596	COOLING		6.49	442	442	57.9	18.8
45	10	45.2	38.8	6.17	37013	5.41	80	65	15	25909	11518	37427	PASSIVE		6.49	426	426	87.9	21.3
45	8	36.2	38.1	6.94	33311	5.35	80	66	14	23318	10366	33684	COOLING		6.37	431	431	78.4	24.9

Comp: ZR40K1 Scroll BM: HE / .33 Marathon G-10 Blower 2-row / 6-circuit air coil BTSSC-60 water coil
 Voltage: 230/1/60 Entering Air: 70DB / 60WB CFM: 1850 External Static: .15" WC

In accordance with ARI 325 & ARI 330 standards and CAN/CSA C446-M94

Capacity Data Model O-55-HPCW (nominal 4 ton)

Heating

EWT	Igpm	Lpm	LWT	Diff	HAB	Pres Drop	EAT	LAT	Diff	Btu's Out	Comp Amps	Comp Watts	Blower Amps	Blower Watts	Total Watts	COP	CSA COP	Suct	Disc Pres
70	10	45.2	60.4	9.6	56367	8.68	70	104	34	72711	20.9	4501	8.83	593	5094	4.2	3.47	79	266
60	10	45.3	52	7.9	47517	8.74	70.2	100	29	63035	19.1	4076	8.6	591	4666	4.0	3.24	67	240
55	10	45.2	47.7	7.3	43774	8.65	69.8	97	27	58992	17.9	3866	8.45	587	4452	3.9	3.15	61	226
50	10	45.1	43.3	6.5	38977	8.83	70	95	25	53479	17.6	3724	8.64	615	4339	3.6	2.82	56	220
45	10	45	38.8	6.0	35832	8.94	69.8	93	23	49825	16.5	3524	8.64	613	4137	3.5	2.72	50	208
40	12	52.2	35.2	4.7	32541	9.03	70.2	92	21	46356	15.9	3407	8.63	591	3997	3.4	2.56	47	203

Cooling

EWT	Igpm	Lpm	LWT	Diff	Water Output	Pres Drop	EAT	LAT	Diff	Sens. cooling	Latent Cooling	Total Cooling	Comp. Amps	Comp Watts	Blower Amps	Blower Watts	Total Watts	EER	CSA EER
50	10	45	57.2	7.4	38160	17.2	79.9	65	15	33480	4459	38160	Passive		8.98	627	627	60.8	19.5
50	8	36.1	59	8.8	36167	11.5	80.2	66	15	32575	3408	36099	Cooling		8.8	614	614	53.5	23.6
45	10	44.8	54.3	9.5	49494	17.2	80.2	63	18	38182	12476	51485	Passive		8.84	607	607	84.7	26.7
45	8	36.3	56.1	11	46270	11.6	80.4	63	17	37078	10220	47179	Cooling		8.77	602	602	78.3	30.9

Comp: AV5549G BM: HE / .33 Marathon G-10 Blower 4 row / 12-circuit air coil BTSSC-84 water coil
 Voltage: 230/1/60 Entering Air: 70DB / 60WB CFM: 1850 External Static: .2" WC

In accordance with ARI 325 & ARI 330 standards and CAN/CSA C446-M94

Capacity Data Model R-65-HAC (nominal 5 ton)

Heating

EWT	Igpm	Lpm	LWT	Diff	HAB	Pres Drop	EAT	LAT	Diff	Btu's Out	Comp Amps	Comp Watts	Blower Amps	Blower Watts	Total Watts	COP	CSA COP	Suct	Disc Pres
70	12	54.2	61.5	8.5	61000	6.88	70	108	37	82500	26	5884	6.69	462	6346	3.8	3.26	81	284
60	12	52.5	52.3	7.7	53616	6.94	70	102	32	72513	23.6	5343	6.44	458	5800	3.7	3.11	69	250
55	12	54.2	48.0	7.0	50266	6.94	70	99	30	67982	22.5	5091	6.52	456	5547	3.6	3.04	64	234
50	12	54.2	43.5	6.6	47125	6.94	70	97	28	63735	21.4	4851	6.61	436	5287	3.5	2.98	559	219
45	12	53.4	38.8	6.2	44181	6.94	70	95	26	59752	20.4	4622	6.62	452	5074	3.5	2.90	54	206
40	12	52.9	33.9	6.1	42778	6.94	70	93	26	57856	19.9	4512	6.59	441	4953	3.4	2.87	52	199

Cooling

EWT	Igpm	Lpm	LWT	Diff	Water Output	Pres Drop	EAT	LAT	Diff	Sens. cooling	Latent Cooling	Total Cooling	Comp. Amps	Comp Watts	Blower Amps	Blower Watts	Total Watts	EER	CSA EER
50	12	54.2	45.2	5.00	36000	25.4	80	67	12	25200	11203	36403	PASSIVE		6.61	436	436	83.2	15.5
50	10	45.2	44.8	5.40	32400	17.3	80	67	12	22680	10083	32763	COOLING		6.52	444	444	73.6	18.4
45	12	54.2	38.1	6.88	49500	25.4	80	65	14	34650	15404	50054	PASSIVE		6.44	429	429	118	21.3
45	10	45.2	37.6	7.43	44550	17.2	80	65	14	31185	13864	45049	COOLING		6.49	426	426	105	25.6

Comp: AH5561E BM: HE / .5 Marathon G-12 Blower 4 row / 12-circuit air coil BTSSC-84 water coil
 Voltage: 230/1/60 Entering Air: 70DB / 60WB CFM: 2000 External Static: .2" WC

In accordance with ARI 325 & ARI 330 standards and CAN/CSA C446-M94

Water Flow Vs. Pressure drop Tables

BTSSC-60 Turbotec® Exchanger		
(Igpm)	(Psig)	(Psig) c/w valve
12	6.71	12.2
10	4.35	8.65
8	2.85	5.41
6	1.92	2.97
4	1.10	1.35

BTSSC-84 Turbotec® Exchanger		
(Igpm)	(Psig)	(Psig) c/w valve
12	6.88	12.5
10	4.85	8.83
8	3.15	5.83
6	2.0	3.65
4	1.35	2.0

Air Flow Vs. External Static Pressure

G-10 Delhi Blower	
External Static Pres.	CFM available
.10	1966
.15	1885
.20	1777
.25	1657
.30	1581

G-12 Delhi Blower	
External Static Pres.	CFM available
.10	2182
.15	2092
.20	1972
.25	1839
.30	1755

NORDIC® Heat Pump System Trouble Shooting Guide

Fault	Possible Cause	Verification	Recommended Action
Compressor not operating	Power Failure	Electric circuit test shows no voltage on the line side of compressor contactor.	Check for blown fuse at heat pump's disconnect box or blown fuse
	Disconnect switch open	Voltmeter shows no voltage on the line side of the compressor contactor.	Determine why the disconnect switch was opened, if all is OK close the switch.
	Fuse blown	At heat pump disconnect box, voltmeter shows voltage on the line side but not on the load side.	Replace fuse with proper size and type. (Time-delay) type "D" Check total load on system.
	Low voltage	Voltmeter shows abnormally low voltage (Below 210 v) at heat pump disconnect switch.	Call power company.
	Burned out motor	Ohmmeter shows no resistance between common and run terminals or between common and start terminals. Note: Be sure compressor overload has had a chance to reset. If comp. is hot this may take several	Determine cause and replace motor.
	Thermal overload on compressor tripped.	Ohmmeter shows reading when placed across R and S terminals and infinity between C & R or C & S. Make sure the internal overload has had time to reset.	If windings are open or overload is faulty, replace compressor.
	Faulty compressor contactor.	Voltage on line side with contactor held closed, but no voltage on one or both terminals on the load side. Points pitted or burned.	Replace contactor.
	Seized compressor due to locked or damaged mechanism.	Compressor attempts to start but trips it's internal overload after a few seconds.	Attempt to "rock" compressor free. If normal operation cannot be established, replace compressor.
Faulty run capacitor.	Check with ohmmeter for shorts, open etc.	Replace if faulty.	

Fault	Possible Cause	Verification	Recommended Action
Compressor not operating	Open control circuit.	<ul style="list-style-type: none"> • Thermostat not calling for heat. • High or low pressure limit open. • Lock-out relay energized. 	Locate open control and determine cause. Replace faulty control if necessary.
	Compressor repeatedly locks out on it's LOW pressure safety control.	Open contacts on low pressure safety limit switch. Lock out relay energized. Water heat exchanger frozen.	Check for "low" or "no" water. Restore proper water flow. Thaw out heat exchanger.
Compressor "short cycles"	Intermittent contact in electrical control circuit.	Normal operation except too frequent starting and stopping.	Check anticipator in thermostat. Make sure setting is for "longest cycle" or max. amps.
Unit trips off on "LOW" suction pressure control.	Low water flow	Manually open water valve and measure water flow with a flowmeter.	Check well pump for proper operation. Check water valve for proper operation. Replace.
	Water supply too cold.	Measure temperature of water. Check flow rate with spec. sheet to determine if proper gpm is available.	Increase flow to proper gpm.
	Ambient air too cold.	Measure return air temp. Should be above 60°F.	Restrict air flow temporarily until room comes up to temperature.
	Faulty low pressure ctrl. Faulty low "temp" ctrl.	Refrigerant pressure control should open on drop at approx. 45 psig. Temp. ctrl. will open in about 1 minute if water flow is interrupted or if unit is run with suction pressure below 50 psig.	Both controls should reset automatically. Heat pump can then be restarted by resetting the lock-out relay. (Turn power off then back on) Replace faulty control if it will not reset.
	Low refrigerant charge.	Check water temp. and flow. Clean heat exchanger. If suction is still low check return air temp. Normal suction is 50-60 psig.	Add refrigerant slowly. Check for possible leaks.
Low or "no" air conditioning	No water flow.	Check flow with flowmeter or other method.	Check water pump operation.
	Supply water temp too warm	Check temperature against performance chart in engineering section.	Increase water flow and blower speed to compensate for warmer water temperatures.

Fault	Possible Cause	Verification	Recommended Action
Low or "no" air conditioning	Open control circuit	Thermostat not set to signal operation.	Turn room thermostat down.
	Reduced air flow.	Check for: 1. Dirty air filter. 2. Fan belt slipping. 3. Broken blower belt. 4. Inoperative blower motor.	1. Replace filter 2. Tighten blower belt. 3. Replace belt. 4. Replace blower motor.
Insufficient domestic hot water. NOTE: Hot water available only during the heating mode.	Circulator pump not operating.	Visually inspect the pump to see if shaft is turning. Use an amprobe to measure current draw.	Replace if faulty.
	Blockage or restriction in the water line or hot water heat exchanger.	Check water flow and power to pump. Check water lines for obstruction.	Remove obstruction in water lines. Acid treat the domestic hot water coil.
	Thermostat limit is open.	Check contact operation. Should close at 120°F and open at 140°F.	Replace thermostat if faulty.
	Disconnect switch open, or fuse blown in electrical supply to hot water tank.	Check both line and load sides of fuses. If switch is open determine why.	Replace blown fuse or breaker or close switch.
	Reset button tripped on hot water tank.	Check voltage at elements with multi meter.	Push reset button.
	Thermostat on hot water tank set too low. Should be set at 120°F.	Visually inspect the setting.	Readjust the setting to 120°F.
	Heat pump not running enough hours to make sufficient hot water.	Note the amount of time the heat pump runs in any given hour.	Temporarily turn up the tank thermostats until colder weather creates longer run cycles.

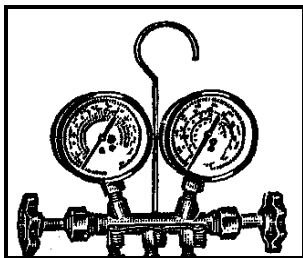

Refrigeration Gauges

Trouble Shooting Tools

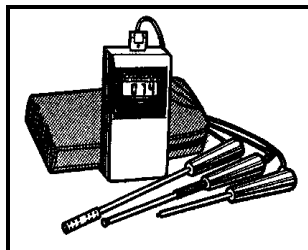

Digital Thermometer



Amprobe



Dole flow control Valve

The Dole® flow control is a simple, self-cleaning device designed to deliver a constant volume of water from any outlet whether the pressure is 15 psig or as high as 125 psi. The controlling mechanism consists of a flexible orifice that varies its area inversely with pressure so that a constant flow is maintained.



In-line Flowmeter

NORDIC® O - Series (230-1-60) Schematic

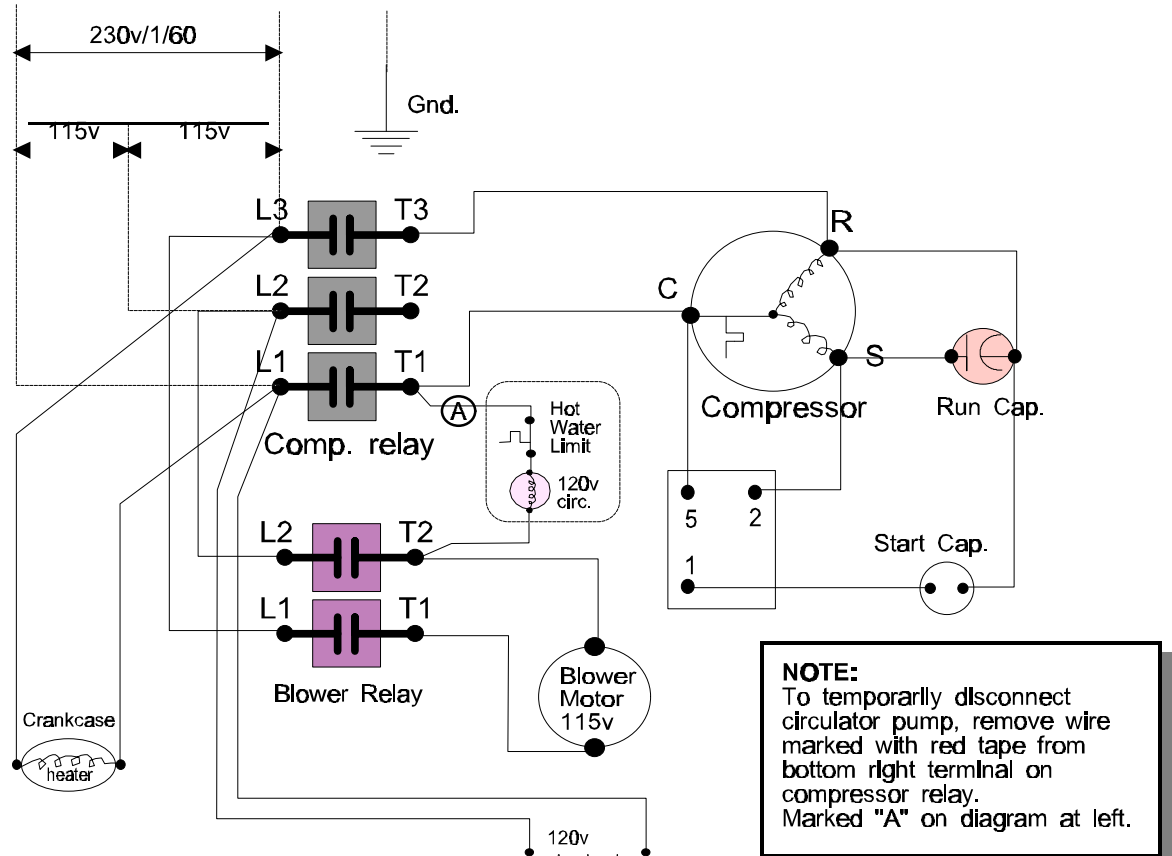

NOTE:
 To temporarily disconnect circulator pump, remove wire marked with red tape from bottom right terminal on compressor relay. Marked "A" on diagram at left.

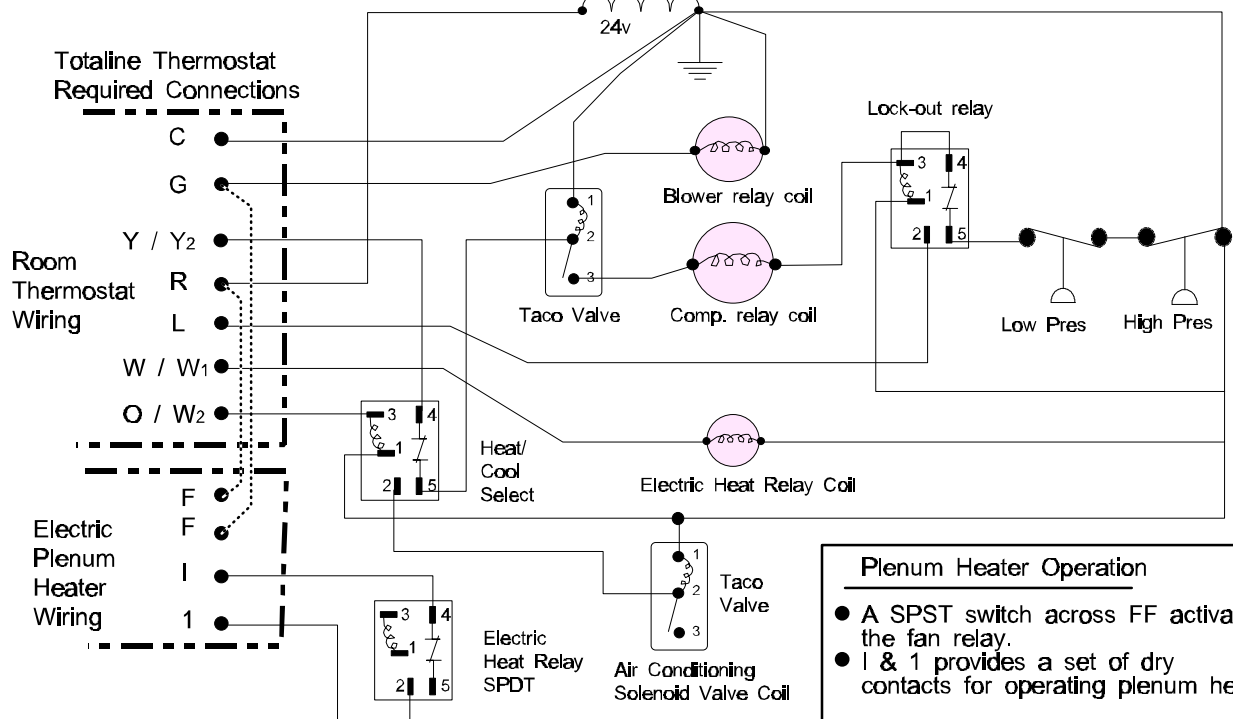

Plenum Heater Operation

- A SPST switch across FF activates the fan relay.
- I & 1 provides a set of dry contacts for operating plenum heater.

NORDIC® O - Series (230-1-60) Electrical Box

Field
T'stat
Wiring

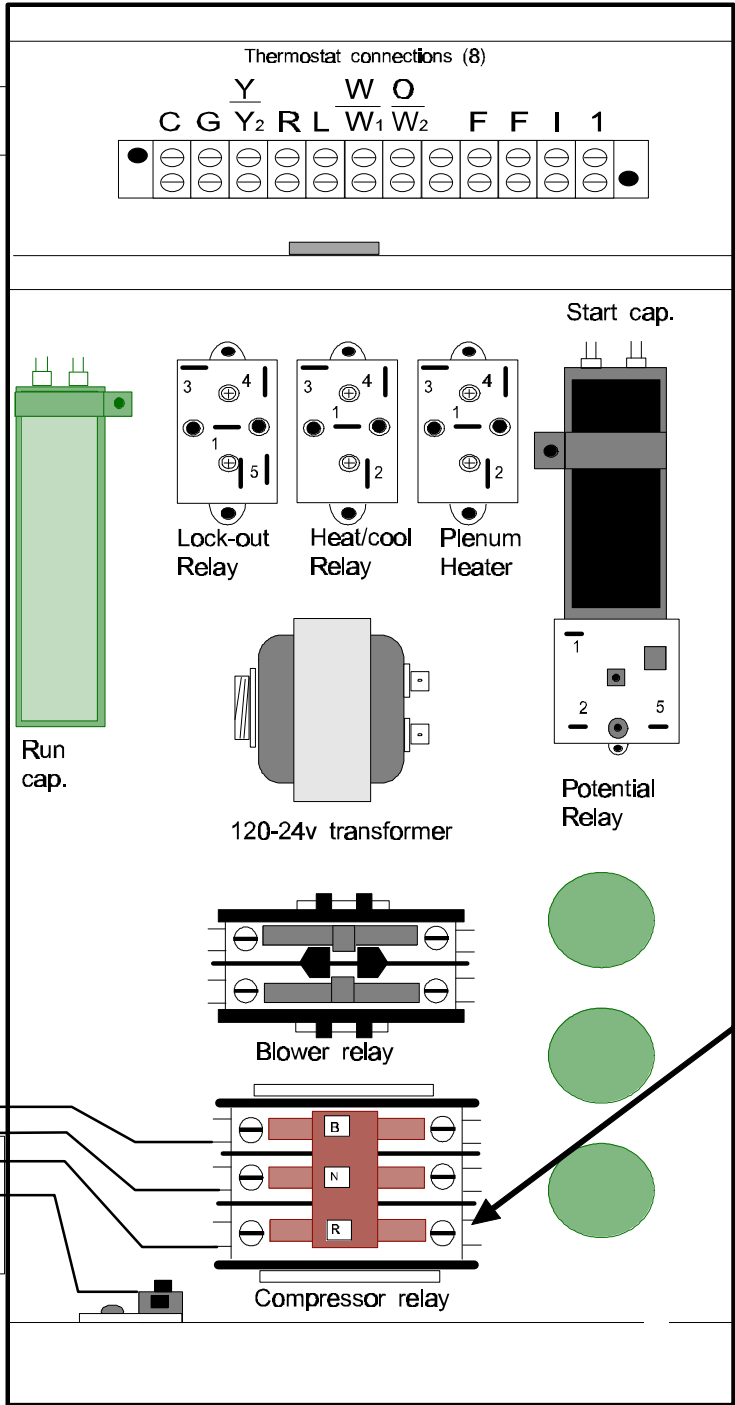

Low Voltage Wiring

Use an 18-8 conductor cable. Connect C, G, Y/Y₂, R, L W/W₁, O/W₂ in terminal box to the corresponding letters on the thermostat supplied.

- C- common
- G- blower
- Y/Y₂- compressor
- R- hot supply
- L- Compressor lock-out light
- W/W₁- Plenum heater relay
- O/W₂- Reversing Valve

Plenum Heater Wiring

Use an 18-4 wire to connect:

FF to FF in heater

I 1 to I 1 in heater

Hot water Circulator Pump Special Instructions

Note: If heat pump is to be operated without the hot water circulator connected to the water tank and flooded with water, remove the wire marked with "RED" tape located here. This pump is water lubricated and must **not** be run dry.

230v / 115v Connections

Compressor relay:
Connect L3 to "Black"
Connect L2 to "Neutral"
(middle terminal as shown at left)
Connect L1 to "Red"
Connect "Gnd" to gnd. lug

Heat Pump Electrical Service Requirements 1 phase / 60 Hz. @ 230v AC					15 Kw Plenum Heater 1 phase 60 Hz 61.5 amps @ 240v Ac
Model	Min. Circuit Ampacity	Min. Circuit Ampacity	TD fuse or Breaker	Thermostat Wire	
O-45	29	8-3	40	18-8	
O-55	32	8-3	40	18-8	
O-65	37	6-3	50	18-8	

NORDIC® O - Series (208-3-60) Schematic

Passive Cooling Schematic Diagram

Taco® Water Valve
208-230 3ph 50-60hz.

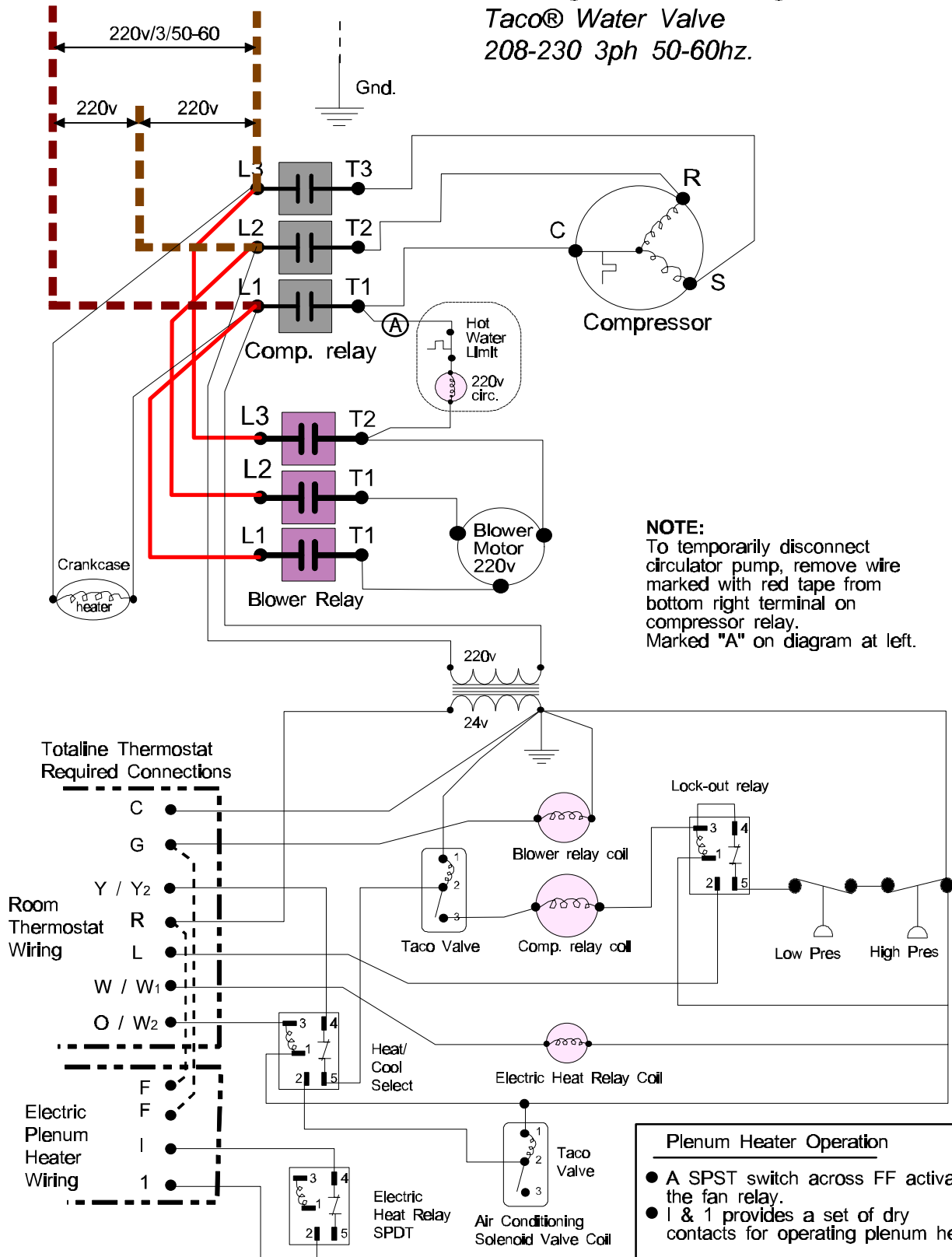

Plenum Heater Operation

- A SPST switch across FF activates the fan relay.
- I & 1 provides a set of dry contacts for operating plenum heater.

NORDIC® O - Series (208-3-60) Electrical Box

Electrical Box Block Diagram- Field Wiring 208-230 / 3ph / 50-60 Hz.

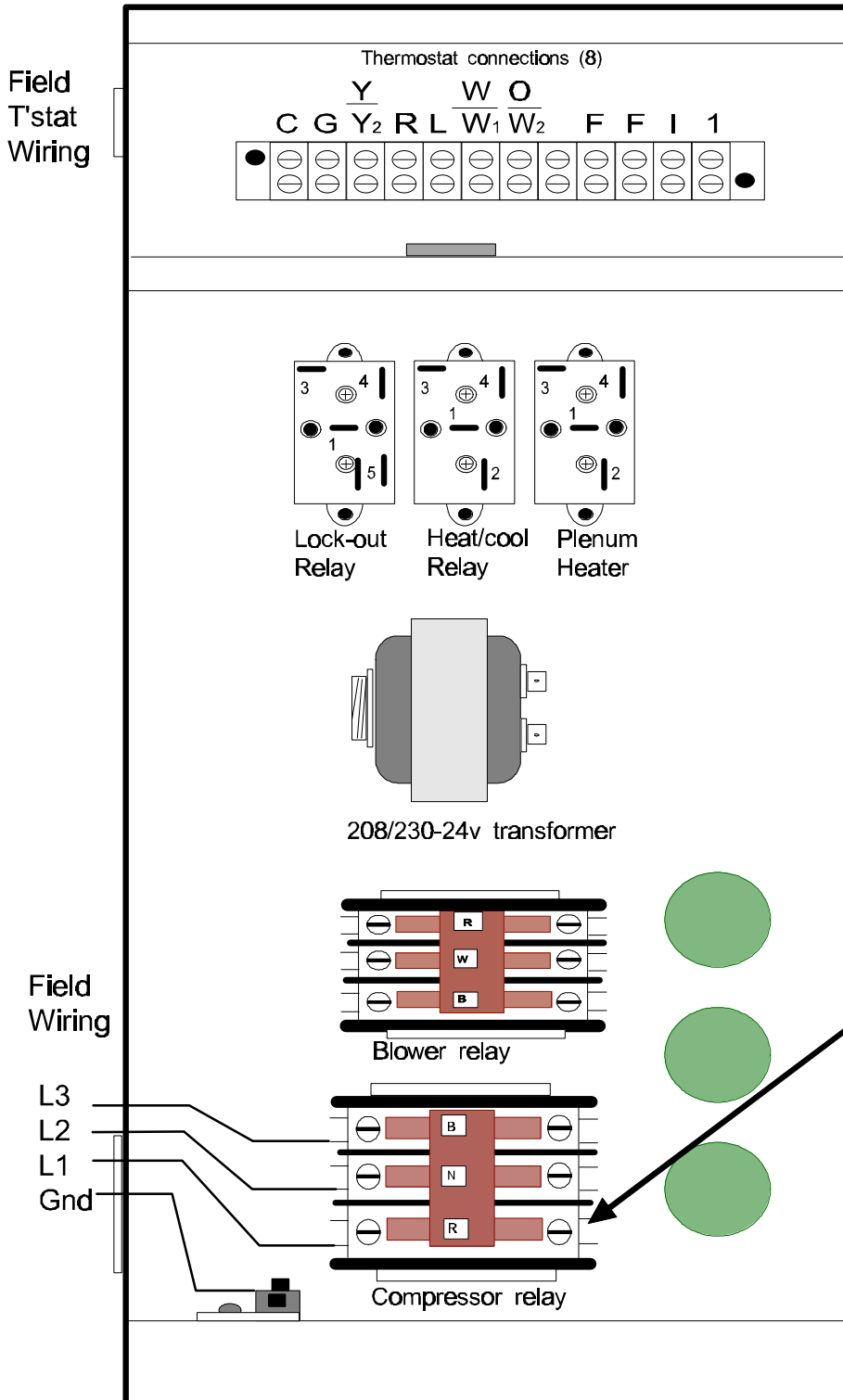

Low Voltage Wiring

Use an 18-8 conductor cable. Connect C, G, Y/Y₂, R,L W/W₁, O/W₂ in terminal box to the corresponding letters on the thermostat supplied.
 C- common
 G- blower
 Y/Y₂- compressor
 R- hot supply
 L- Compressor lock-out light
 W/W₁- Plenum heater relay
 O/W₂- Reversing Valve

Plenum Heater Wiring

Use an 18-4 wire to connect:
 FF to FF in heater
 I 1 to I 1 in heater

Hot water Circulator Pump Special Instructions

Note: If heat pump is to be operated without the hot water circulator connected to the water tank and flooded with water, remove the wire marked with "RED" tape located here. This pump is water lubricated and must **not** be run **dry**.

208-230v Connections

Compressor relay:
 Connect L3 to "Phase 3"
 Connect L2 to "Phase 2"
 Connect L1 to "Phase 1"
 Connect "Gnd" to gnd. lug

NORDIC® Thermolec® Plenum Heater Connections

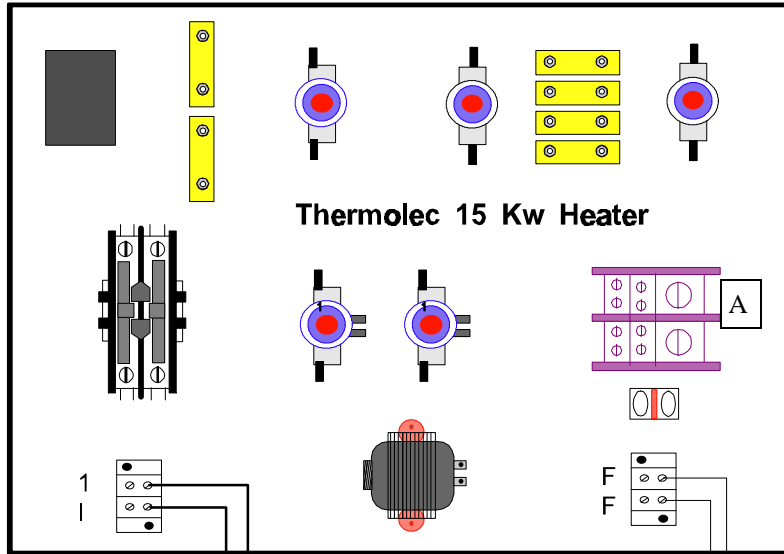

- ### Electrical Connection to a NORDIC® Heat Pump
1. Connect the proper electrical supply with a suitable breaker to the main terminal block shown. ("A" at left)
 2. Using 2 conductors in a length of 18-4 thermostat wire, Connect "T" and "1" in the control section of the heat pump's electrical box to "T" and "1" terminal strip in the plenum heater as shown.
 3. Using the remaining 2 conductors, connect "F" and "F" in the heat pump's electrical box to "F" and "F" in the plenum heater.

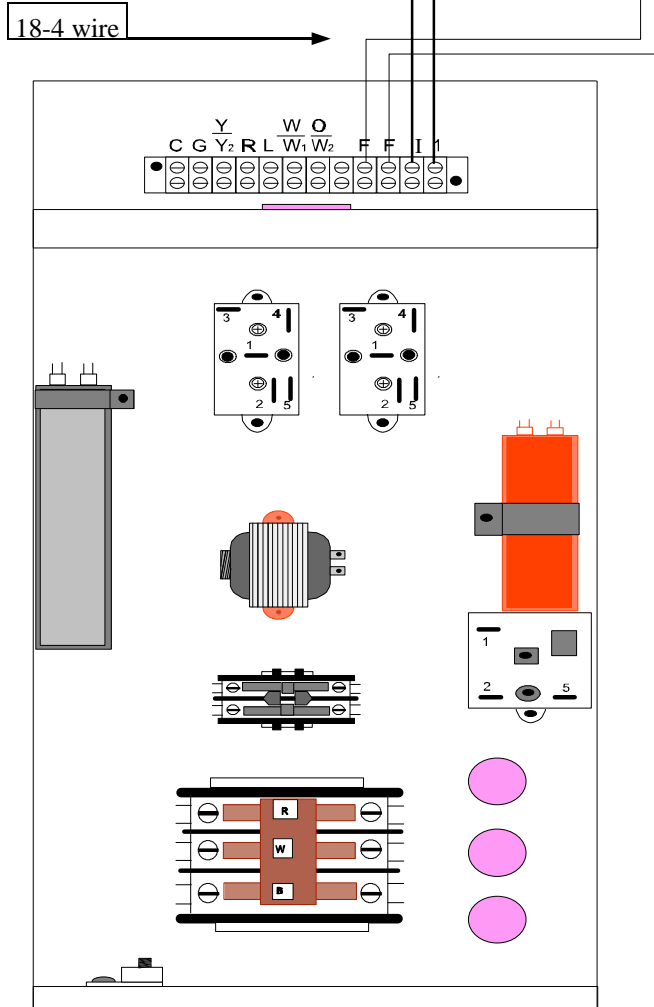

Thermostat Operation

The NORDIC® heat pump comes supplied with a 2-stage heating / 1-stage cooling auto change-over digital thermostat.

The heat pump is already pre-wired for this stat and requires only the connections mentioned above for full operation.

The thermostat operates the heat pump as the first stage of heat bringing the electric backup on only if required. There is a 2° differential between the first and second stage of heat. The thermostat automatically changes between heating and cooling as required by the building.

L I M I T E D W A R R A N T Y

MARITIME GEOTHERMAL LTD. warrants that the heat pumps manufactured by it shall be free from defects in materials and workmanship for a period of (1) ONE YEAR after the date of installation or for a period of (1) ONE YEAR AND (60) SIXTY DAYS after the date of shipment, whichever occurs first. In addition MARITIME GEOTHERMAL LTD. warrants that the compressor shall be free of defects in materials and workmanship for an additional period of (48) FORTY-EIGHT MONTHS from said date.

MARITIME GEOTHERMAL LTD. shall, at it's option repair or replace any part or parts covered by this warranty which shall be returned to MARITIME GEOTHERMAL LTD., transportation charges prepaid, which, upon examination proves to be defective in materials or workmanship. Replacement or repaired parts and components are warranted only for the remaining portion of the original warranty period.

This warranty is subject to the following conditions:

1. The NORDIC® heat pump must be properly installed and maintained in accordance with MARITIME Geothermal LTD.'s installation and maintenance instructions.

2. The installer must complete the “**Installation Data Sheet**”, have it endorsed by the owner and return it to Maritime Geothermal Ltd. within 21 days after the installation of the unit.

3. It is the responsibility of the building or general contractor to supply temporary heat to the structure prior to occupancy. These heat pumps are designed to provide heat only to the completely finished and insulated structure. Start-up of the unit shall not be scheduled prior to completion of construction and final duct installation for validation of this warranty.

4. It is the customer's responsibility to supply the proper quantity and quality of water.

If the heat pump, manufactured by MARITIME GEOTHERMAL LTD. fails to conform to this warranty, MARITIME GEOTHERMAL LTD. 's sole and exclusive liability shall be, at it's option, to repair or replace any part or component which is returned by the customer during the applicable warranty period set forth above, provided that (1) MARITIME Geothermal LTD. is promptly notified in writing upon discovery by the customer that such part or component fails to conform to this warranty. (2) The customer returns such part or component to MARITIME GEOTHERMAL LTD., transportation charges prepaid, within (30) thirty days of failure, and (3) MARITIME GEOTHERMAL LTD. 's examination of such component shall disclose to it's satisfaction that such part or component fails to meet this warranty and the alleged defects were not caused by accident, misuse, neglect, alteration, improper installation, repair or improper testing.