

Nordic[®]
 E U R O P E

Installation Manual

NORDIC® models Wec-45-55-65-80-175

Revision 5.0

February 00

Liquid-to-Water Geothermal Heat Pumps

Table of Contents

Water Well Requirements	3	Groundloop design.....	13	Refrigerant Circuit HACW	24
Optimum Placement	5	Circulator pumps	15	Electrical Requirements	25
Plumbing the Heat Pump	5	Loop Flushing & antifreeze.....	17	Performance Charts	26
Safety Controls	7	Engineering Data	19	Trouble Shooting Guide	31
Starting the Heat Pump	10	General Specifications	21	Electrical Diagrams	34
Maintenance	11	W Series features	22	Warranty	36

METRIC VERSION

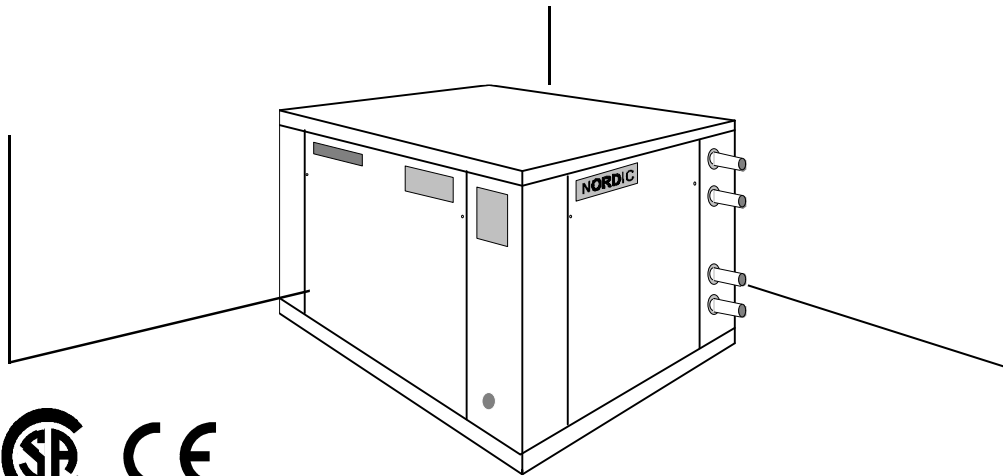

Water Well or Groundloop Operation

Maritime Geothermal Ltd.
 P.O. Box 413
 Petitcodiac, N.B. E0A 2H0

Email: nordic@auracom.com
www.discribe.ca/nordic

A NORDIC® Groundwater Heat Pump System

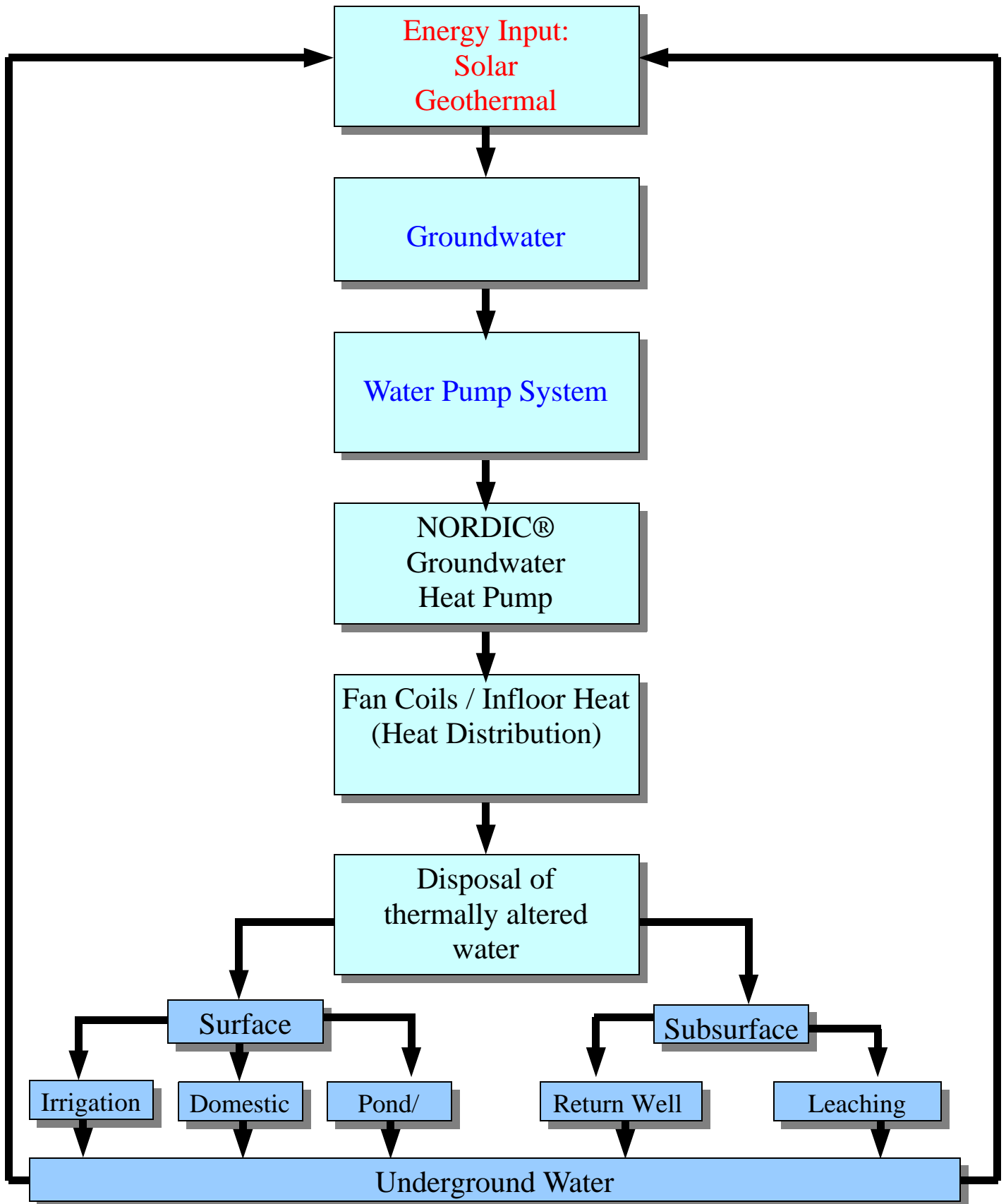

NORDIC® Liquid-to-Water System Prerequisites

There are five specific parts or sub-systems to a groundwater heat pump installation:

The source of energy (groundwater)	Water Well
The method of supplying energy to the heat pump	Water Pump System
Converting the energy to a useable form	Heat Pump
Distributing the heat	Infloor Heat / Fan Coil Units
Returning the exhaust water to the earth for reheating	Water disposal

Water Well Requirements

1. A DRILLED well of 127 mm diameter or larger.
2. Well casing properly sealed or grouted into rock.
3. Water flow preferably entering well at a depth of 25m or more.
4. Temperature of well at least 4.4°C. (Normally 7+ °C.)
5. Well must be able to supply requirements of BOTH heat pump and residence usage at the same time with maximum drawdown from static level of 9 m.

Water Requirements For Nordic® Heat Pumps

Model	Heat Pump	Home	Total
Wec-45	32 L/min	14	46
Wec-55	45 L/min	14	59
Wec-65	55 L/min	14	69
Wec-80	90 L/min	14	104
Wec-175	113 L/min	14	127

Note: These are minimum water requirements based on an entering water temperature of 7° C.

Water Pump System

1. A submersible pump is generally required. Must be able to pump the required water flow listed above at a minimum of 210 kPa at the dynamic pumping depth of your well.
2. Make sure you select the pump using the pump manufacturers pump chart.
3. Use a minimum of 135 litre equivalent air bladder tank.
4. Make sure the pump will be able to pump the required flow for the heat pump while maintaining 275 kPa on the water lines for usage in the rest of the home.

The Heat Pump

A heat pump with Btu output capable of heating the home in all winter weather conditions should be selected using a “rule of thumb” as follows:

Model	Sq. M of Home*
Nordic Wec-45	160
Nordic Wec-55	250
Nordic Wec-65	325
Nordic Wec-80	500
Nordic Wec-175	700

*NOTE: Rule of thumb, use proper heat load software to

Maritime Geothermal Ltd. recommends that anyone considering the installation of a heat pump in their home or office have a professional heat loss / load calculation prepared on the building to determine the heating and cooling requirements. The correct sizing of the heat pump to the home can only be properly accomplished with the use of specialized software programs designed for this job.

Discharge Water Methods

1. Although we highly recommend it, you do NOT necessarily have to have a return well.
2. Some of our customers do one of the following with their return or waste water:
 - A. Run it into a drain or ditch.
 - B. Pond, river or stream.
 - C. Leaching field.

In most instances if you run the water right out on top of the ground it will soak back into the ground in less than 15m of travel. If suitable care is taken to insure that the drain pipe runs downhill and the end of the pipe is protected by a bale of hay or spruce bows etc. the end of the pipe will not freeze. When snow comes it will usually cover the entire process much like a small spring. The above information is intended to give the prospective user/purchaser some insight as to the general requirements for a successful application of the NORDIC® heat pump.

NORDIC® “W” Series - Open Loop Disposal Methods

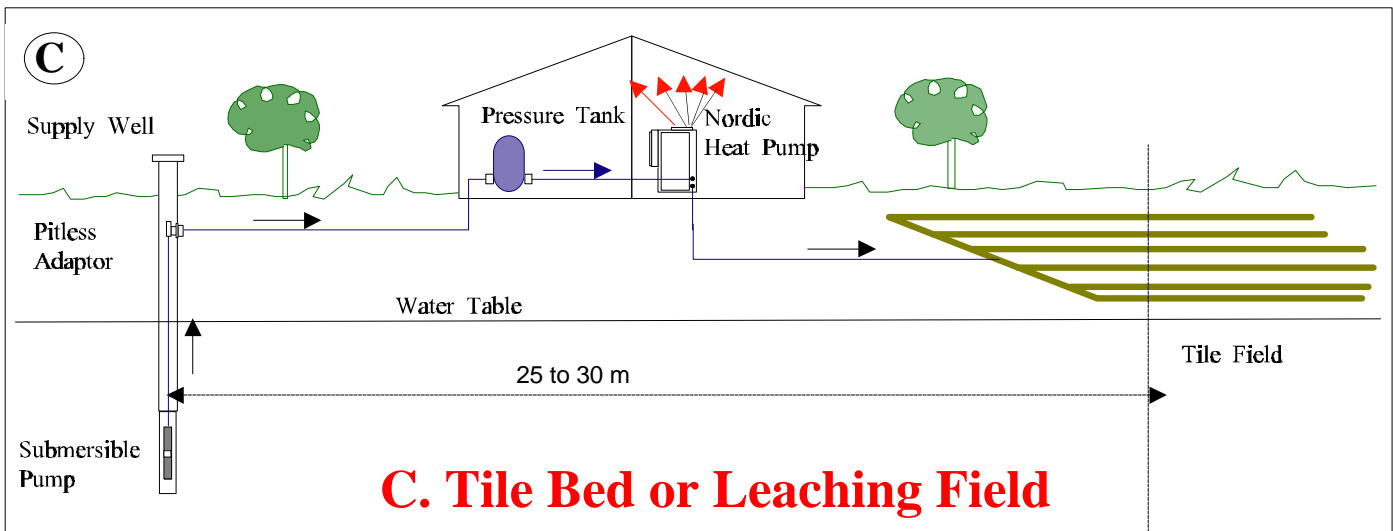
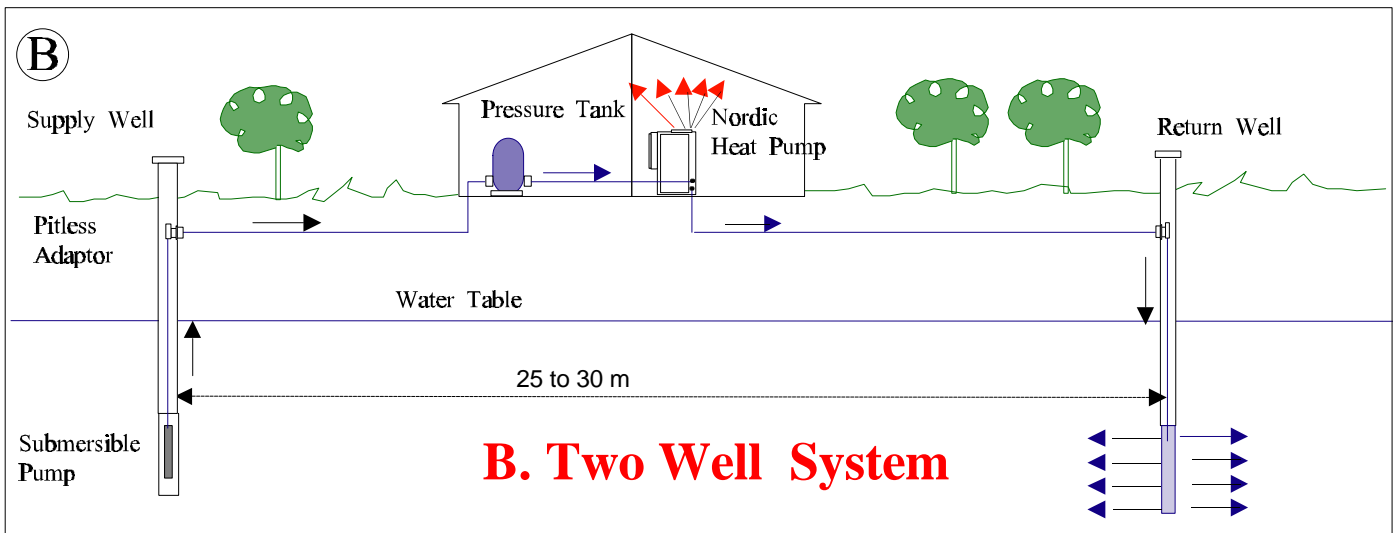
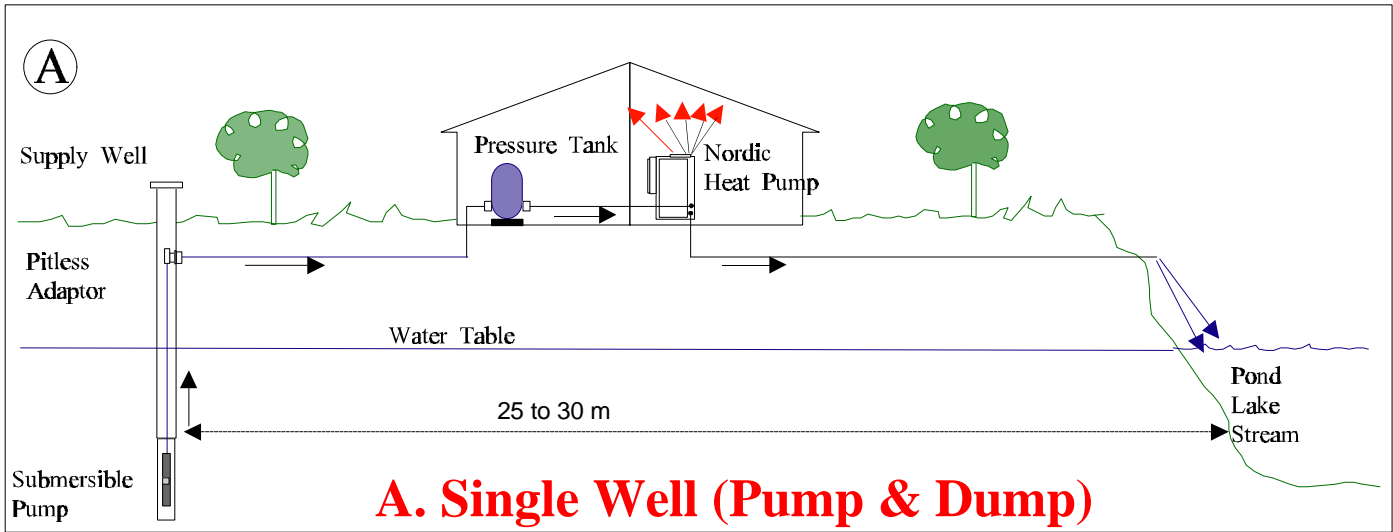

Unpacking

When the heat pump reaches its destination it should be unpacked to determine if any damage has occurred during shipment. Any visible damage should be noted on the carrier's freight bill and a suitable claim filed at once.

The heat pump is well constructed and every effort has been made to insure that it will arrive intact, however it is in the customer's best interest to examine the unit thoroughly when it arrives.

Placement

The location of liquid-to-water heat pump inside the home should be determined by:

1. The ease at which piping runs can be connected to the in-floor heating headers on the output side of the unit.
2. Space availability in a mechanical room for the hot water distribution tank and associated pumps etc.
3. Ease of access to the water well supply and discharge lines or groundloop lines.

If possible the four main service doors should remain clear of obstruction for a distance of (.6m) so that servicing and general maintenance can be carried out with a minimum of difficulty. Raising the heat pump off the floor a few inches is generally a good practice since this will prevent unnecessary corrosion of the bottom panel of the unit.

We recommend that the heat pump be placed on a piece of 50 mm Styrofoam covered with 6.5 mm plywood. The Styrofoam will smooth out any irregularities in the cement floor while the plywood will distribute the weight of the NORDIC® unit evenly over the Styrofoam. This process will also deaden the compressor noise emitted from the bottom of the cabinet.

As an alternative, several pieces of 50 mm x 100 mm lumber can be placed under the unit running from the electrical connection side to the opposite side of the heat pump. Laying the 50 mm x 100 mm lumber in this manner will give the best support since they will be at right angles with the internal steel compressor and heat exchanger support.

Plumbing the Heat Pump (water well application)

When installed on a water well, the NORDIC heat pump must be supplied with an adequate water supply, since in essence, water is the fuel for the unit. It is imperative that the flow requirements listed in the engineering section be closely adhered to.

When setting up the unit, Maritime Geothermal Ltd.

recommends the installation of a water flow meter on the discharge line so that the exact amount of water flowing can be determined at a glance. Once the correct flow of water has been established and determined to be consistent, the water flow meter could be removed from the line.

NOTE: Installing unions at each end of the meter and similar unions on a piece of pipe of the same length, allows the user to insert the meter in the line whenever the flow of water is to be checked and then remove the meter so that it does not deteriorate from day to day usage

Plumbing lines, both supply and discharge, must be of adequate size to handle the water flow necessary for the heat pump. For distances less than 12 m from the pressure tank, 19 mm copper or plastic lines should be run while for longer distances we recommend that 25 mm plastic or copper lines should be run to the heat exchanger. Similarly, a 25 mm line should be run from the discharge pipe to the method of disposal.

Install a P/T (Pete's Plug) plug on the Water (IN) and Water (OUT) lines just outside the heat pump so that it is easy to record the water in and out temperatures and pressures accurately.

Ideally there will be water flow available in excess of the requirement of the heat pump. In such a situation the proper pump can be selected to **maintain a pressure of 200 to 275 kPa on the lines when the heat pump is operating.** However in some cases a well can supply a heat pump only if the minimum requirement for water is used.

Supply water flow to the heat pump can be con-

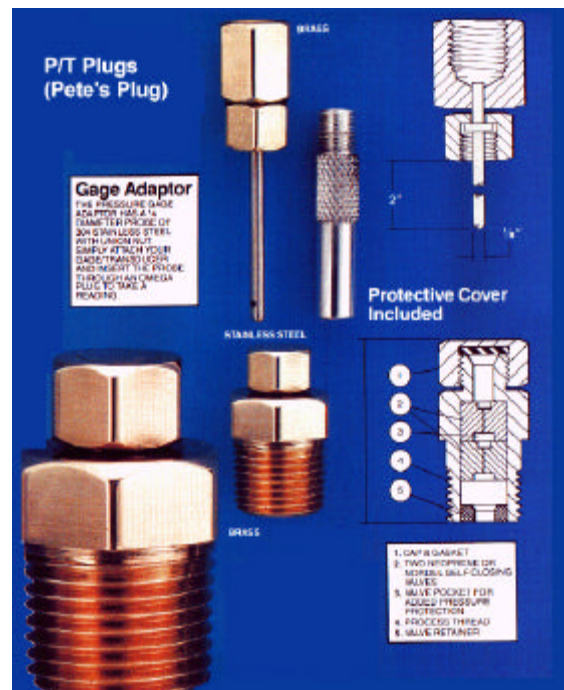
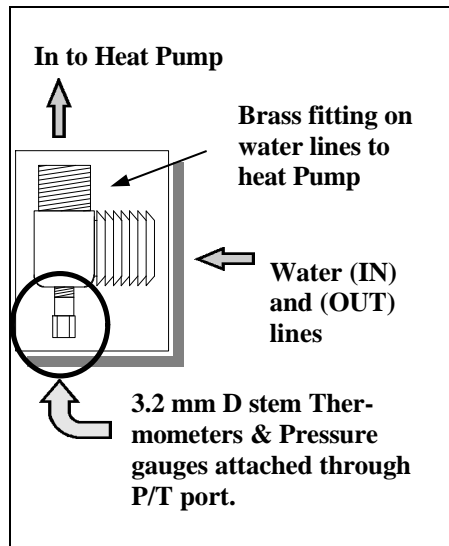

Fittings and accessories available for P/T plug application to heat pump.

NORDIC® "W" Series Typical Plumbing

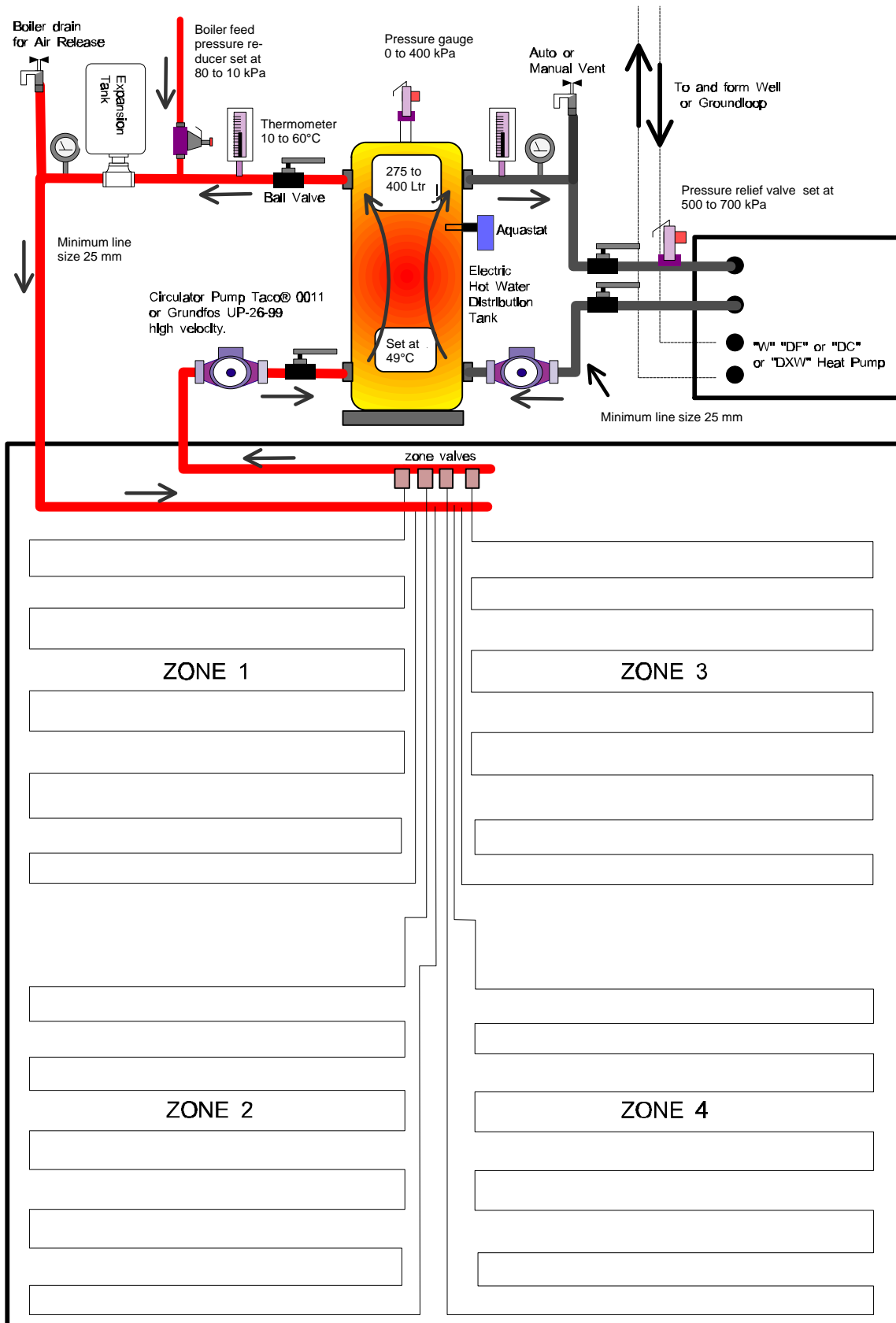

trolled very accurately by the installation of a reverse action pressure valve in the supply water discharge line of the unit. If the unit is a heating / cooling unit then a dual high pressure / low pressure valve or a pair of valves must be installed

Another method of regulating the flow is by the use of a "DOLE" valve. This valve will automatically control the amount of water flowing through it by varying the diameter of a flexible rubber orifice through which the water passes. If either of such valves is needed they can be supplied and installed by your dealer.

All water line valves on both the supply and discharge lines should be either BALL or GATE valves since a GLOBE valve will create too much restriction across the line possibly causing the heat pump to trip out on it's low pressure safety cutout control as a result of insufficient water flow.

Exposed water lines will have a tendency to sweat when the heat pump is in operation, therefore it is recommended that both the water supply and discharge lines be insulated with suitable insulation.

Hot Water Connections

Connection to the hot water generator feature of the heat pump is accomplished by teeing into an electric or oil fired hot water tank with a capacity of 180 litre minimum. A typical piping diagram is shown on page 11 in this manual. Be sure to note the position of the check valve and the direction of water flow.

One should be sure the tank is filled with water and is under pressure before activating the heat pump. Slightly loosen the copper union on the hot water discharge pipe to allow air to escape from the system before the unit is started. This step will make certain that the water circulator is flooded with water when it is started.

Since the pump is water lubricated, damage will occur to the pump if it is run dry for even a short period.

The union on the discharge water line may have to be purged of air several times before good circulation is obtained. A hand placed several feet down the line will sense when the water is flowing.

The thermostats on the hot water tank should be set to 49°C. since the heat pump has an internal thermostat set at a low of 52°C. By setting the tank thermostats as described, the heat pump will try to keep the tank above the cut-in point of the electric element settings thus generating hot water from the heat pump only. During summer, or periods of high demand, the electric elements will energize to help make hot water.

NOTE: If (2) shut-off valves are located on the hot water lines as shown in the diagram on page 11, be sure that the valves are open when the heat pump is operating. If both valves are closed when the heat pump is operating, water will expand in the hot water heat exchanger and could cause damage to the hot water circulator pump.

Water Disposal Methods

Water disposal methods vary from area to area however some consideration should be made to prevent the cooled discharge water from immediately coming in contact with the supply source. **Generally speaking, returning water to a second well, pond lake or stream is acceptable while returning water to the same well will usually cool the water so much that the heat pump will shut off on it's low pressure / temperature safety control.**

A return well should be a minimum of 25 m from the supply well for residential applications. The water returned to the well will not be necessarily be pumped into the same aquifer, depending on underground conditions, but the return well does have to be able to supply the same quantity of water as the amount you wish to recharge into it.

If the static level (level when not being pumped) of a well is high (3 to 6 m from the surface) it may be necessary to place a **watertight** well cap on the well to keep the return water from flowing out the top of the well. This cap is commonly required since a certain amount of pressure is needed to force the return water back down the well if the static level is high.

Return wells are not always the answer and to some it may be more satisfactory to pump the water to a pond or away into the woods.

Water recharged naturally through percolation into the soil is an alternative to a recharge well. The water discharged will generally soak into the ground within a distance of 15 to 30 m. If care is taken to make sure the end of the pipe does not freeze then this method of disposal works well.

Safety Controls

The NORDIC reversible W series heat pump has three built in safety controls which are designed to protect the unit from situations which could damage it.

A. LOW REFRIGERANT PRESSURE (heating mode)

The low refrigerant pressure control is designed to shut the unit down if the refrigerant evaporating pressure becomes too low thus risking the danger of freezing conditions in the evaporator.

There are only (4) reasons why this control would activate and they are:

1. Low water flow. (See requirements for each model)
2. Low water temperature. (Below 4.5 °C)
3. Dirty or fouled heat exchanger.
4. Low refrigerant charge.

B. HIGH PRESSURE CONTROL

The second safety control is a high pressure safety limit which monitors compressor discharge pressure. This device will not normally trip unless there is an interruption in water flow.

Such a situation could occur if the hot buffer tank circulator pump failed or if the heat pump had an extremely dirty air filter.

C. LOW SUCTION TEMPERATURE CONTROL (cooling mode)

NORDIC® W-Series Hot Water Production

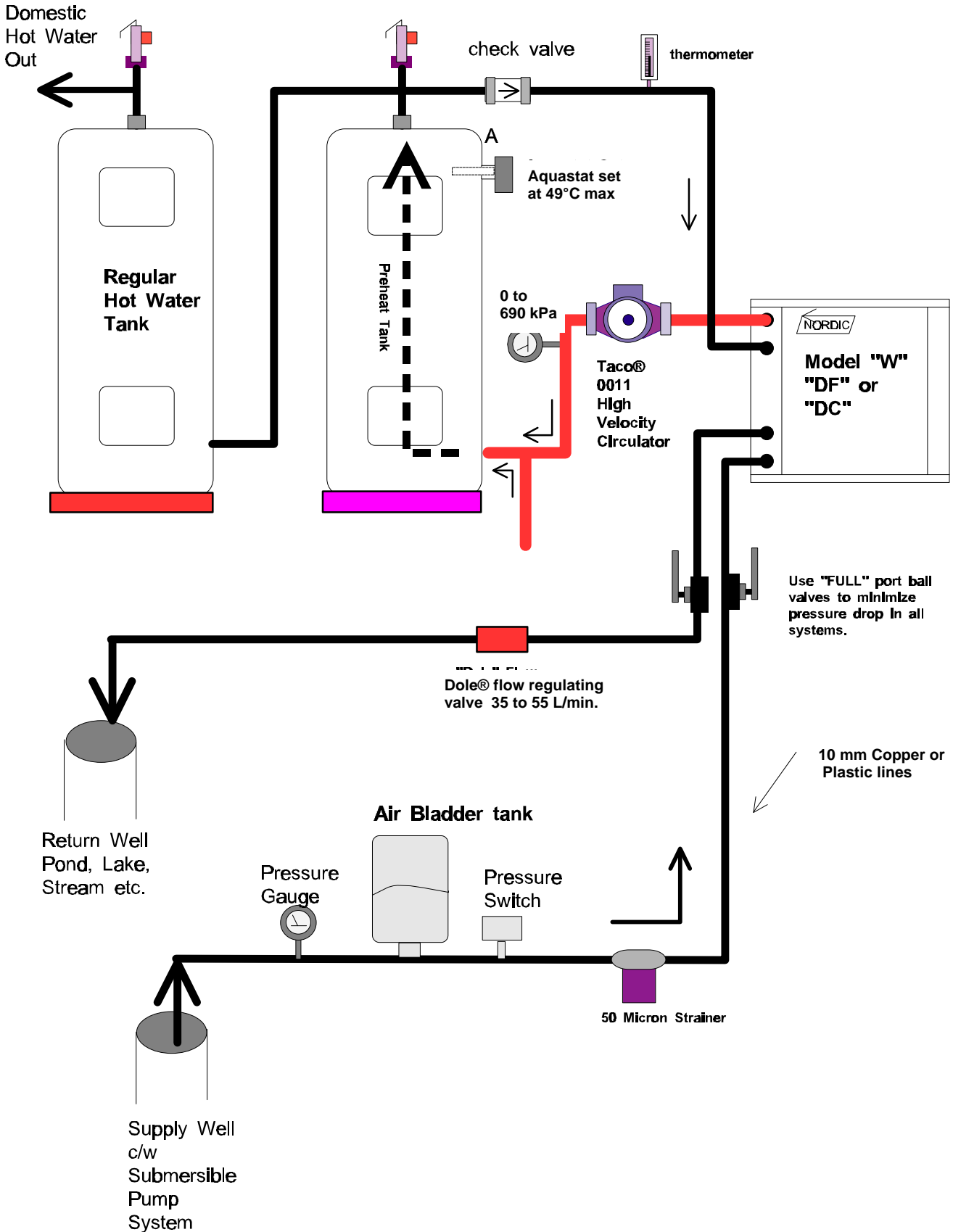

NORDIC® W Series (2 fitting) Buffer Tank Piping

Lines "C" and "D" can be run to any device that requires hot water such as infloor heating, car wash, laundry or commercial kitchen.
See other diagrams in this section for further details on typical plumbing schematics.

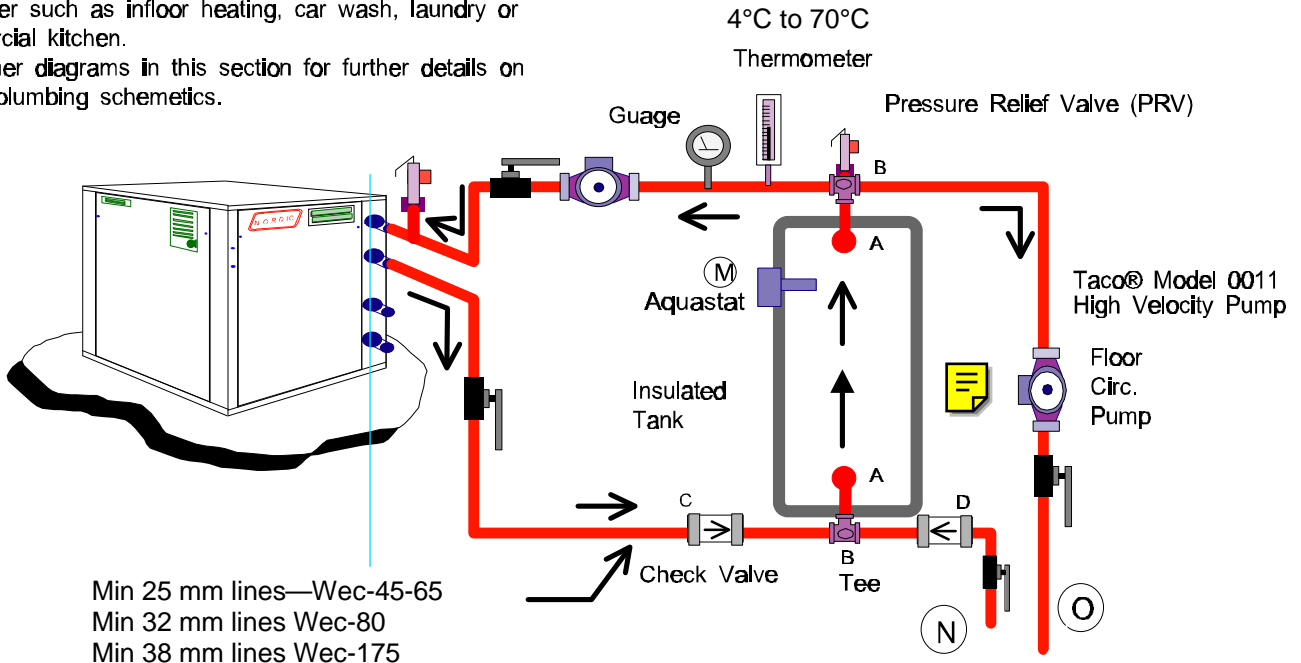

IMPORTANT INSTRUCTIONS

1. Diagram above shows the proper manner for plumbing a tank that has only (2) ports.
2. The tank must have at least 38 mm fittings at "A" to accommodate the flow from the heat pump and the floor circulator pump when both are in operation.
3. The water line between "A" on the tank and the "Tee" at "B" should be at least 38 mm.
4. Install a check valve at "C" and "D" to prevent back flow through the floor system or the heat pump when only one of the two pumps is running.
5. The tank should have an additional 19 mm fitting at "M" to allow for an immersion (well style) probe thermostat.

This control works during the cooling mode to shut down the compressor as in A above.

If one of these controls trips it will activate a **LOCK-OUT RELAY** which prevents the unit from restarting until power to the control circuit is broken (by turning the thermostat to the **OFF** position and then back on again) or the electrical supply to the unit is broken by opening the heat pump breaker and then closing it again. If one of these controls trips there is a serious problem with the system and it must be rectified if the unit is to maintain good service.

NOTE: Under no circumstances should the heat pump lock-out relay be reset more than twice in an hour. If the heat pump is shutting off because of LOW or NO water flow then repeated resetting of the unit could cause the heat exchanger to freeze and rupture destroying the heat pump.

Electrical Connections

The NORDIC unit is supplied with an opening for 19 mm conduit nipple on the right side of the unit. An additional knockout (13 mm) is provided to facilitate connection of an external circulator pump to the set of dry contacts provided. Above this is another 9.5 mm hole for the thermostat wire. A wiring diagram is located inside the electrical box cover for quick reference and although the connections to be made are quite simple, Maritime Geothermal Ltd. recommends that a properly qualified electrician be retained to make the connections and wire the thermostat.

The NORDIC unit may be supplied with a thermostat and connections are clearly marked on the control box. Using a 3-conductor (18 gauge) wire suitable for the job, connect the terminals in the heat pump electrical box to the corresponding terminals on the thermostat.

Starting the Heat Pump

BEFORE starting the heat pump the following areas should be rechecked to assure proper operation.

1. Check all high voltage field wiring and electrical connections inside the control box for good connection.
2. Check all low voltage thermostat to make sure they are connected properly. Place thermostat HEAT-OFF-COOL switch in the OFF position.
3. Turn on the main power switch. Allow the power to remain ON without starting the unit for a period of 4 hours. Refrigerant migrates to the compressor oil when the compressor is unheated. On most units a crankcase heater is standard equipment on your heat pump and it will warm the compressor, dispelling the liquid refrigerant. Compressor damage can occur if the heat pump has been brought in from a cold location and immediately started up.
4. Turn on the water supply and check all plumbing for leaks.
5. Check all buffer tanks and the domestic hot water tank to be sure it is filled with water before energizing the circuit.

NOTE: The hot water tank should be energized for at least 4 hours before the heat pump is started. A combination of low condenser temperature water and 7° C. water in the hot water tank may cause the unit to shut down on it's low pressure control. If this happens close ONE valve in the hot water circuit to temporarily shut off the flow to the domestic hot water generator. Do not shut off both valves since water expanding in the hot water generator loop may cause damage to the circulator pump housing. When the hot buffer tank has come up to temperature open the valve for normal hot water operation.

Slightly open the union on the hot water discharge pipes to make sure that all air is out of the system and the circulator pump is flooded with water.

6. Make sure all pumps are wired, purged of air and ready to pump water.
7. Vacuum out any dust and debris that may have collected in the unit during installation.
8. Make sure the unit is sitting level.
9. Make sure the proper time-delay fuse has been installed in the fuse box.
10. Have the following tools on hand and know how to use them.

- A refrigeration gauge set.
- An electronic or other accurate thermometer
- An amprobe.
- A water flow meter.

11. Connect your refrigeration gauge set.

12. After the 4 hour warm-up period place the thermostat function switch in the HEAT position, turn up the thermostat. The compressor, main heat exchanger circulators and domestic hot water circulator will start.

NOTE: If the unit is equipped with an electric TACO water valve the valve will open in 30 to 60 seconds followed by the compressor. When the TACO water valve is fully open, an internal switch activates the compressor circuit.

13. Observe the readings on the high and low pressure gauge set. With entering water temperature of 7° to 10°C, the suction pressure (blue gauge) should be approximately 365 to 400 kPa while the head or discharge pressure (red gauge) should be in the area of 1550 to 1900 kPa Depending on the condenser side water flow and temperature. Record this information on the warranty test card.

14. Using an electronic thermometer or other accurate thermometer, record the supply water temp. "IN" and the water temperature "OUT".

The outlet water temperature should be from 2.2° to 4°C. cooler than the inlet water temperature.

15. Record the supply water flow in gpm.

16. Record the condenser (HOT) water flow through the machine. At 45 Lpm. You will see a 4°C to 5.5°C rise through the heat exchanger.

17. Record the voltage at the terminal blocks with a digital voltmeter.

18. At the electrical disconnect switch place the amprobe jaws around the supply wires and record the current in each.

19. Place the thermostat function selector in the COOL position and turn down the stat to a temperature that will cause water chilling to begin. When the aquastat selector switch is set in the COOL mode the reversing valve will be energized.

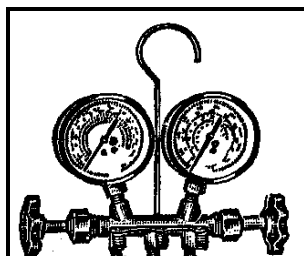

Refrigeration Gauges



In-line Flowmeter

Service Tools

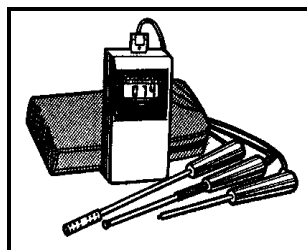

Digital Thermometer

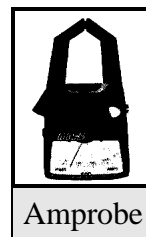

Amprobe

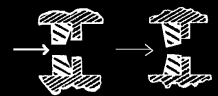
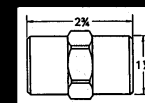

Dole flow control Valve

The Dole® flow control is a simple, self-cleaning device designed to deliver a constant volume of water from any outlet whether the pressure is 100 kPa or as high as 860 kPa. The controlling mechanism consists of a flexible orifice that varies its area inversely with pressure so that a constant flow is maintained.

General Maintenance

As with any piece of equipment there will eventually be some maintenance to be done on the heat pump.

Reversible NORDIC® heat pumps are equipped with coaxial type heat exchangers. These heat exchangers are not manually cleanable however they can be cleaned with a sulfamic acid solution commonly marketed under the trade name "Iron-Out". If you suspect that the water being pumped through the unit is of a poor quality or you notice a decrease in performance after several years of use it may be necessary to have the liquid heat exchanger cleaned.

Maritime Geothermal recommends that a qualified service-man be retained to carry out this procedure since the solution involved is highly corrosive.

Open Well & Hot Water Tank Plumbing Diagram W Series Liquid-to-Water Heat Pumps

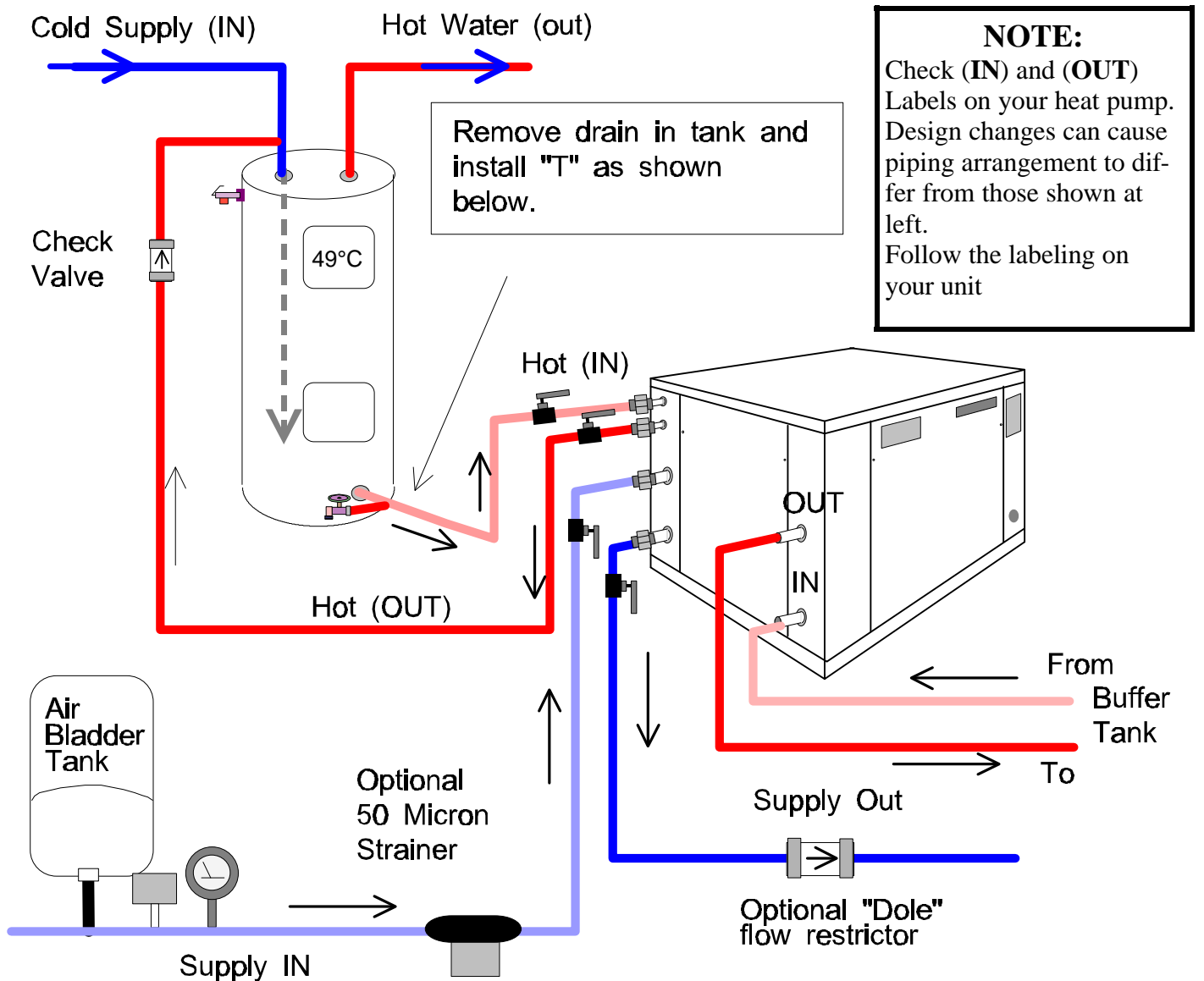
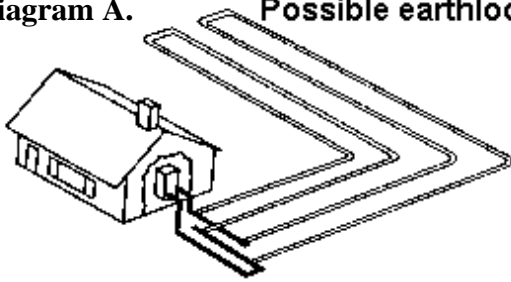
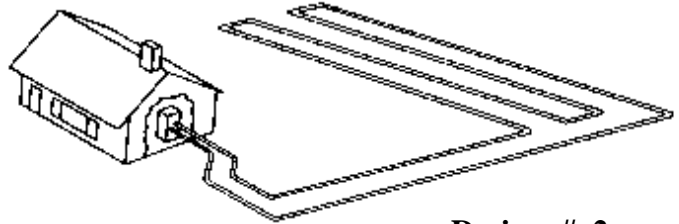

Diagram A. Possible earthloop configurations - Type 3408 High Density PE tubing



Design # 1



Design # 2

Parallel piping - Reverse Return Header System

Series piping - 1 or 2 pipes per trench.

Diagram A.

Shown above are several of the many possible horizontal loop layouts which have been successfully employed in various types of ground conditions.

Design # 1

Shown is a typical reverse return header system and 2 parallel loops. On a 2 ton system each of these loops would be 150m long with 1.3m spacing between the “U” sections, 3m spacing between the loops and buried 1.8m underground.

Design # 2 is a single loop of 32 to 38 mm diameter pipe with a length of 150m x the tonnage of the system and buried to a depth of 1.8m underground. Individual runs of pipe should be kept a minimum of 3m apart.

Diagram B.

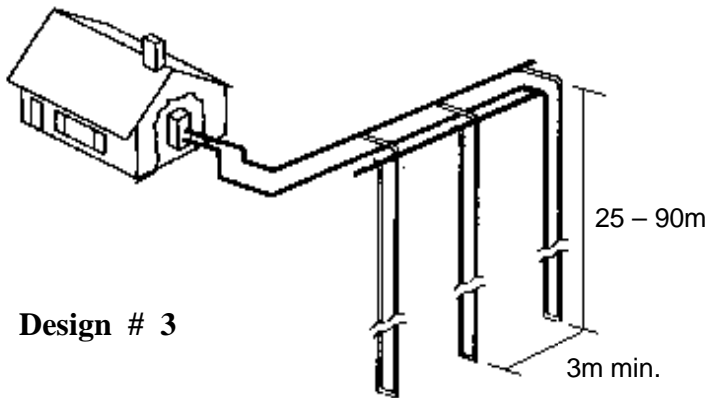

Design # 3

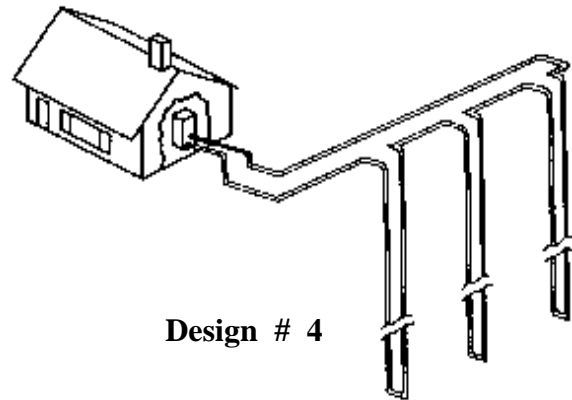

Design # 4

Vertical - Parallel

Vertical - Series

Design # 3.

Shown is a vertical borehole reverse-return header system. Vertical systems generally require 40 to 55m of borehole per ton of heat pump for successful heat transfer to take place with the earth. Boreholes should be spaced a minimum of 3m apart while if land is available, 8m spacing will produce better results. Boreholes should be tremie grouted from bottom to top with bentonite or a mixture of bentonite and neat cement for proper conduction with the earth.

Design # 4.

Shown here is a typical series loop design using 32 to 38 mm pipe for the loops. Some designs incorporate a double “U” tube assembly down the well which allows for better heat transfer between the earth and the loop.

NOTE

Many other loop designs are in common use throughout North America. For a more comprehensive manual on earthloop design refer to our Earthloop Design Manual or contact IGSHPA (International Ground Source Heat Pump Association) and request their earth systems dealer training manual.

W- Series Closed Loop Installation Information

Introduction

Many commercial buildings select a vertical or horizontal closed loop as the earth heat exchanger either because of a lack of available groundwater or for the reduced maintenance costs which can be obtained when compared to open loop systems. Often the problems which occur in a geothermal system are associated with the wells, pumps, or the direct result of utilizing poor quality water or water which is contaminated with sand or other foreign materials. Such contamination can cause premature failure with pumps, water valves, heat exchangers and return wells.

To reduce these problems to a minimum a closed secondary heat exchange system is constructed with *Type 3408 Polyethylene Plastic Pipe* specifically engineered for the job. Materials such as PVC and polybutylene are not recommended since their underground joining process is not as reliable as the fusion process used with type 3408 polyethylene. The earthloop heat exchanger can consist of a single long length of plastic commonly called a **series** style heat exchanger or more commonly is found as a number of **parallel** loops connected to a **reverse return header system**. The series system for homes or light commercial applications up to 10 tons normally is constructed with 32 to 51 mm diameter pipe while the parallel system uses multiple branch loops from 19 to 25 mm connected to a larger header pipe system of 32 to 38 mm diameter. The parallel system offers several advantages such as:

- Less expensive pipe.
- Easier to handle the smaller pipe.
- Lower pressure drop
- Smaller circulator pump(s)

Of course on larger commercial systems it would not be unusual to find header systems with up to 152 mm diameter pipe for fluid flow into and out of the building.

Socket Fusion

Mechanical joints or metal fittings of any kind are not acceptable underground in an earth loop system due to large temperature fluctuations which may loosen and break clamps and the possibility of eventual corrosion perforation in couplings and "T"s".

Fittings and joints are socket or butt fused together into one contiguous unit using a technique developed by the gas industry. A heater tool with the appropriate faces heats both the pipe and fitting for a prescribed period of time and then the two pieces are quickly removed from the heater, inserted together and held in place until the joint cools. When properly done the resulting joint is stronger than the original pipe with no chance of leaks or breaks. For more information on butt and socket fusion techniques see our website at (<http://www.discribe.ca/nordic/fusion.htm>) or request a copy of the Central Tools Butt and Socket fusion manual.

Horizontal Groundloops

Horizontal groundloop systems are most commonly used where land is readily available since they are cheaper to construct than their vertical counterparts. Although many configurations are available, we have found that a parallel system with one (1) 150m "U" pipe per ton placed in a 76m x 1.3m wide x 1.8m deep trench is easy to construct and provides ample ground impact area to adequately supply a 0°C or better Entering Fluid Temperature to the heat pump even in the most severe winter months. (See opposite Diagram A.)

Several companies including "*Thermalworks*" and the International Ground Source Heat Pump Association (igshpa) provide modeling software to size the heat pump to the home and then size the loop to the demand of the home and heat pump. Consideration is given to many factors such as type of ground, moisture content and configuration of loops desired. It is often possible to shorten loop lengths and resulting costs when using some of the newer "*Slinky*" designs of earth-loops. A comprehensive manual dedicated entirely to the installation of groundloops is available from Maritime Geothermal Ltd. which describes in detail the techniques involved in installing a closed loop system.

Vertical Groundloops

Vertical groundloop systems are generally the system of choice for commercial and institutional buildings since the land area available is often limited to parking lots with some adjacent landscaped areas.

Boreholes of 100 to 152 mm diameter are drilled with conventional drilling equipment usually to a depth of less than 90m Each "ton" of heat pump installed requires approximately 46m of borehole. The 19 to 25 mm plastic pipe "U" tubes are fused together using socket fusion techniques and

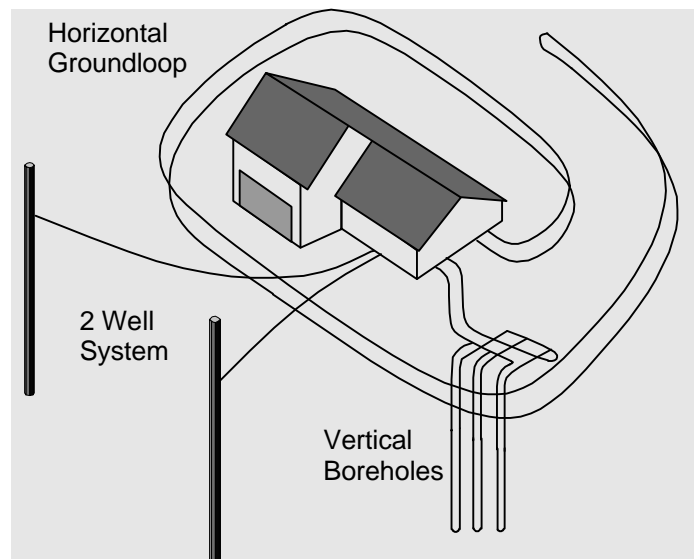

One Example of Piping Layout for Horizontal Closed Loop Heat Pump System (4 ton system shown)

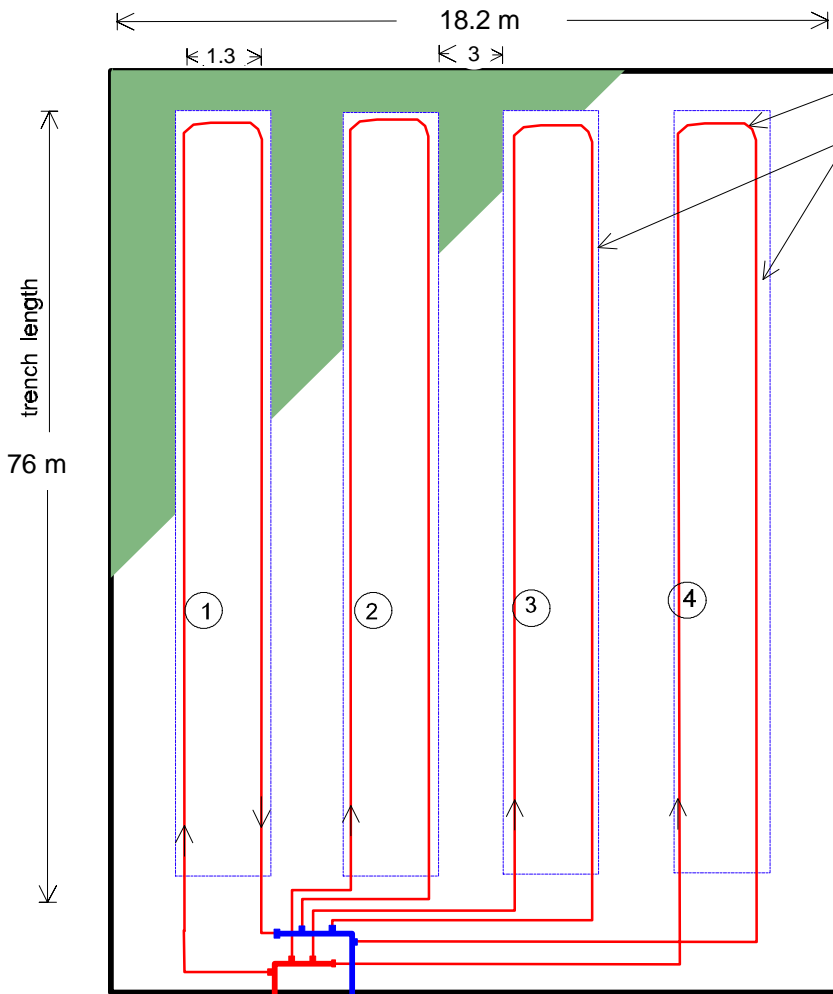

Type 3408 PE tubing.

Excavated trenches minimum 1.3 m wide x 1.8 m deep.

NOTE: Trenches will be back-filled with material which will maximize the thermal conductivity of the adjacent earth.

Each loop consists of 150 m of 19 mm type 3408 PE 1100 kPa (SDR 11) geothermal heat pump polyethylene tubing.

Allow a minimum of 3 m between each trench and preferably 5 to 6 meters if space is available

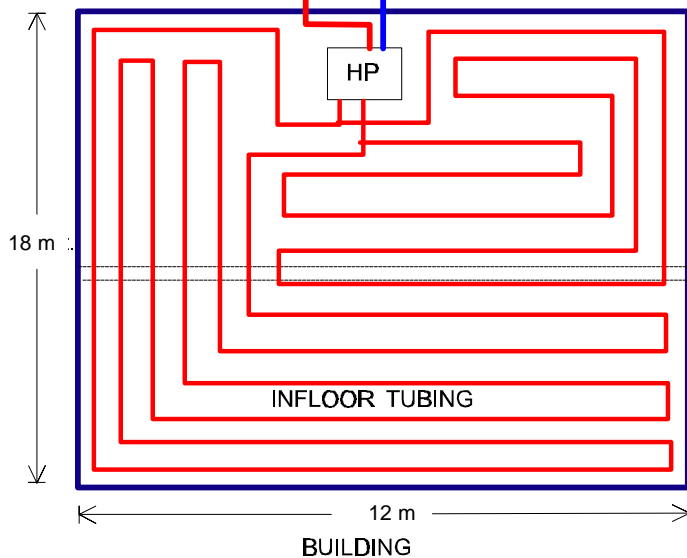
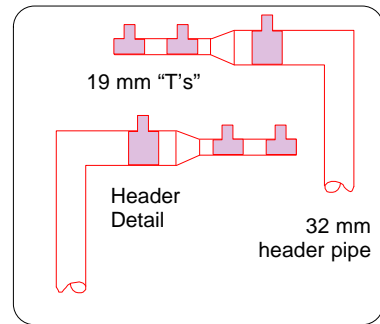

- Insulate all tubing within 3 m of the structure with 13 mm closed cell insulation.
- Piping that is laid in a header trench should be insulated to a point where each loop branches to its individual trench.
- Loop 4 shown above could be left uninsulated to pick up heat in the header trench as long as the header trench is more than 3 m out from the building.
- Manifolding is normally done outside the building using suitable fusion tools.

then pressure tested for leaks at 690 kPa using either water or air. Provision should be made to allow enough extra pipe to extend from the boreholes to the proposed location of the header system. Prior to inserting down the hole the assembly must be filled with water so that buoyancy will be at a minimum when inserting the “U” tube. Cap the ends so that mud and debris cannot enter the loops during insertion and grouting. A piece of heavy rebar or galvanized pipe is attached to the bottom 3 to 5 m of the “U” tube with tape to add weight

Table 1. Antifreeze Percentages by Volume

Protection down to:	-12°C	-9.5°C	-7°C	-4°C
Methanol	25%	21%	16%	10%
Propylene Glycol	38%	30%	22%	15%

to the assembly and also prevent it from curling up and gouging into the side of the borehole during insertion. The entire length of the assembly should be taped every 3 m to create greater rigidity in the “U” tube assembly as it is installed in the borehole. The “U” tube is inserted into the borehole along with the tremie pipe and the borehole is tremie grouted from bottom to within 3 m of the top with a mixture of neat cement and bentonite or 100% bentonite. When using bentonite refer to the manufacturers instructions for mixing and select a product that provides a total solids content of from 25 to 30% when mixed.

Horizontal trenches from 1.3 to 1.8m deep are dug alongside the boreholes to the building so that a reverse return (first pipe out on the supply line is the last pipe back on the return line) header pipe arrangement can be constructed to tie all the loops together. Lay out the header system so that air cannot be easily trapped in the header using a technique approved by IGSPHA or the local governing authority. Use a shovel to break away any ground between the trench and the boreholes and dig a relief no less than 30 times the diameter of the pipe to allow the pipe to bend to the header pipe without kinking. Be very careful not to disturb the original ground under the relief so that you do not have to worry about the pipe being kinked through compaction of the earth under the pipe after the trench is backfilled. Fuse the individual smaller loops to the main header loops and extend these into the home by drilling through the concrete wall or by rising up the outside of the basement wall or slab and entering the structural part of the home or building above grade. Any piping that comes within 3 m of the structure should be insulated with 10 to 13 mm closed cell armaflex insulation to prevent freezing from occurring near any structural part of the building. Likewise, all piping inside the building must be insulated to prevent condensation and subsequent dripping onto floors or walls.

Circulator Pump Module

When the groundloop has been brought inside the home or building to the location of the heat pump it must be connected to the pump module which generally consists of (1) Grundfoss® Model UPS 26-99 or Taco® Model 0011 pump for systems up to 3 ton and (2) pumps for systems up to 5 ton.

These units must be able to pump at least 9.5 to 12 l/min. per ton of heat pump for proper operation of the system. To calculate the size of pumps required use the pressure drop tables for the diameter and type of tubing used along with all elbows, T’s etc and the pressure drop through the unit’s heat exchanger to arrive at:

$$(\text{total ft of head}) \times (12 \text{ l/min./ton}) \times (\text{No. of tons})$$

Heat Pump to Circulator Piping

The heat pump must be connected to the circulator pump module with a lineset suitable for the flow required with minimum pressure drop. Common line sizes would be 19 mm rubber or plastic for heat pumps from 1 to 2.5 ton while for unit sizes 3 through 5 ton, 25 mm lines should be used. The installation of P/T plugs (pressure / temperature) pronounced “Pete’s plugs” should be installed on both the entering and leaving lines at the heat pump. The P/T plug will allow the installer or homeowner to check water flow through the loop by measuring the pressure difference through the heat exchanger and comparing this pressure drop to that of the appropriate model in the engineering section. (see **Pressure Drop vs. Water Flow Table**)

Table 2. Litres of fluid per 30 meters of pipe

Type of Pipe	Diameter	Volume (Litres)
Copper	25 mm	15.5
	32 mm	24.2
	38 mm	34.8
Rubber Hose	25 mm	14.8
Polyethylene	19 mm IPS SDR11	10.6
	25 mm IPS SDR11	17.0
	32 mm IPS SDR11	32.2
	38 mm IPS SDR11	41.3
	51 mm IPS SDR11	71.5
Heat Exchanger	Average	6.0
Flush Cart Tank	381 mm x .9 m high	10.8

Flushing & Purging the Earthloop

Once the earthloop has been installed and all connections are completed to the heat pump and pumping station the entire plumbing system should be pressure tested with air to 690 kPa to make sure there are no leaks on any of the inside fittings. Soap all joints and observe that the pressure remains



Inside Plumbing - Heat Pump to Groundloop (Galvanized or PVC Fittings)

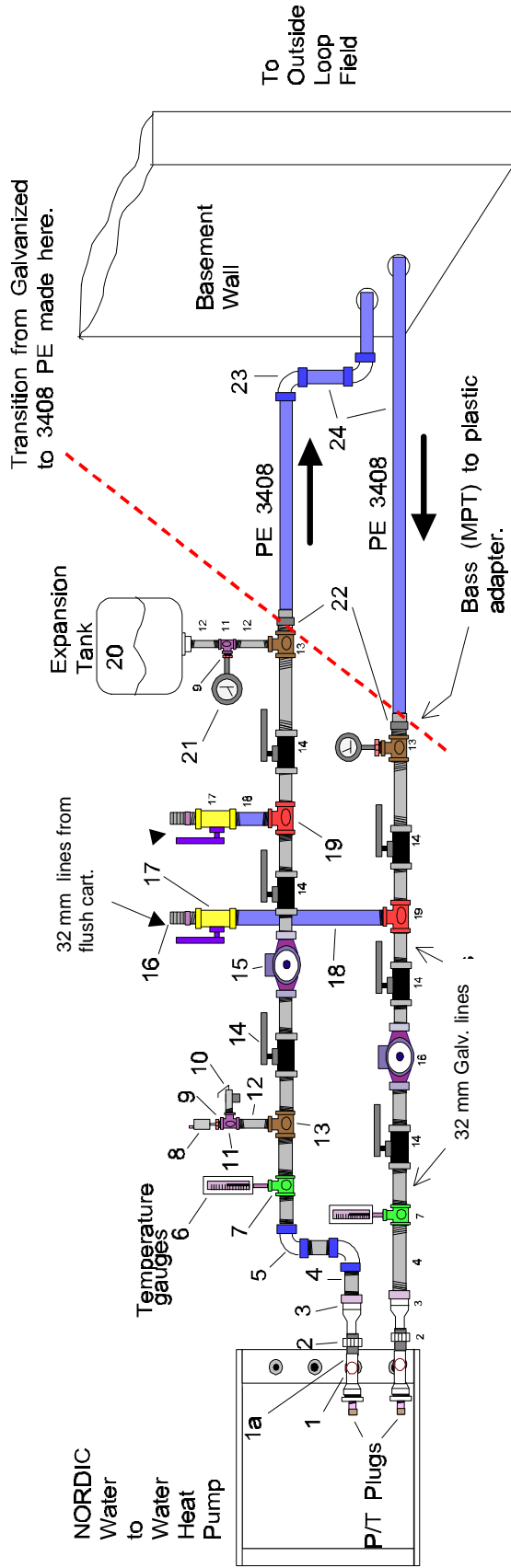

Shown above is one possible method of connecting a geothermal heat pump to a typical polyethylene groundloop. The configuration above allows for two pumps, however, one pump may be omitted if pressure drop calculations dictate. Provisions are shown for incoming and outgoing pressure gauges and thermometers as well as an expansion tank and a pressure relief valve. Flush cart connections are permanently installed. The ball valves on the flush cart lines can be used for manually purging small quantities of air from the system.

LEGEND:

- 1. 19 mm copper "T"
- 1a. 19 mm Type "L" copper pipe
- 2. 19 mm copper union.
- 3. 19 to 32 mm Copper to female adaptor.
- 4. 32 mm galv. nipple or threaded pipe.
- 5. 32 mm galv. 90° elbow.
- 6. -20°C to 60°C thermometer (19 mm MPT)
- 7. 32 x 32 x 13 mm galv. "T"
- 8. Automatic air vent (6 mm MPT)
- 9. 19 x 6 mm reducing bushing.
- 10. 500 kPa pressure relief valve (19 mm MPT)
- 11. 19 mm galv. "T"
- 12. 19 mm galv nipple.
- 13. 32 x 32 x 19 mm galv. "T"
- 14. 32 mm full port ball valve.
- 15. Taco® 0011 or Grundfos UP-26-99 pump.
- 16. 25 mm Barbed adaptor to 25 mm MPT.
- 17. 25 mm full port ball valve.
- 18. 25 mm galv. Nipple or threaded pipe.
- 19. 32 mm x 32 x 25 mm galv. "T"
- 20. 10 Litre expansion tank.
- 21. 0 to 200 kPa gauge (6 mm MPT)
- 22. 32 mm PE 3408 to brass MPT transition adaptor.
- 23. 32 mm PE 3408 90° elbow.
- 24. 32 mm PE 3408 Plastic earthloop pipe.

The above technique could also be employed using PVC elbows, fittings etc.

constant for 1 hour.

NOTE: If you use pressure gauges permanently installed on the system as in the case of a demonstration situation etc. be careful not to exceed the maximum pressure rating of the gauges to avoid damage to their mechanism.

When satisfied all connections are leak free, release the air pressure and connect a flush cart (see diagram) to the flushing access ports at the pump station. A temporary flushing system can alternately be constructed using a 170 litre barrel and a pump with sufficient volume and head capability to circulate fluid at a velocity of at least 1 cm/sec. through all parts of the loop. Begin pumping water through the earthloop making sure that the intake of the pump stays submerged at all times by continuously adding water from a hose etc. Water flowing back on the return line should be directed below the water level in the barrel or flush tank to prevent air being mixed with the outgoing water. Once the lines have been filled and no more air bubbles are appearing in the line, adjust the flow valves to circulate water through the heat pump using the same technique as described above. When all air is removed reverse the flow of water through the lines by interchanging the flush cart lines and purge again. You will be able to visibly tell when all air is removed.

Installing Antifreeze

In most mid and northern areas of the US and in all of Canada it is necessary to condition the loop fluid by the addition of some type of antifreeze solution so that it will not freeze during operation in the winter months. This antifreeze is required because the loop fluid will normally reach a low entering temperature of -2.2°C to 0°C . and refrigerant temperatures inside the heat pump's heat exchanger may be as low as 11°C cooler. See the antifreeze concentration chart at left for details of freeze protection afforded under different concentrations.

NOTE: Add enough antifreeze to allow for a temperature 11°C lower than the expected lowest loop fluid temperature entering the heat pump.

NOTE: Although many different antifreeze solutions have been employed in geothermal systems, the alcohols such as methanol or ethanol have the most desirable characteristics for earthloop application. The overall heat transfer characteristics of these fluids remain high although care must be taken when handling pure alcohols since they are extremely flammable. Once mixed in a typical 25% by volume ratio with water the solution is not flammable. In situations where alcohols are not allowed as a loop fluid due to local regulations then propylene glycol is a non-toxic alternative which can be substituted. Propylene glycol should only be used in cases where

alcohols are not permitted since the heat transfer characteristics are less desirable and it becomes more viscous at low temperatures which increases pumping watts. The volume of fluid that your loop system holds can be closely estimated by totaling the number of ft. of each size pipe in the system and referencing **Table 2.** the for approximate volume per 30 meters.

When the volume of the loop has been calculated and the appropriate amount of antifreeze is ready for addition by referencing **Table 1.**, drain the equivalent amount of water from the flush cart or mixing barrel and replace it with the antifreeze. When using alcohols be sure to inject it below the water line to reduce initial volatility of the pure antifreeze. If the loop is large and the tank is small it may be necessary to refill the tank with antifreeze several times to get all the antifreeze into the loop. Pump the loop for 5 to 10 minutes longer to insure the remaining fluid has been well mixed.

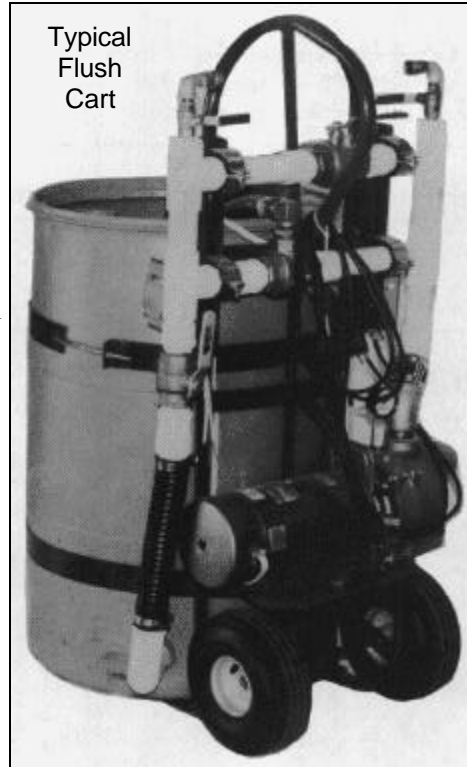

Initial Pressurization

At this point open all valves in the flow circuit and slowly close off the supply and return flush cart valves in a manner that leaves about 175-300 kPa on the system. If an air bladder expansion tank

is used the bladder should be charged to the above pressure before actual water pressure is put on the system. Systems employing a commercially available loop pump kit that do not have an expansion tank, thermometers and pressure gauges will experience a greater fluctuation of pressure in the loop between winter and summer. This fluctuation is normal since expansion and contraction of the loop fluid must be handled by the elasticity of the plastic loop. Pressurize the loop to a pressure of 300 kPa when installing a system in the fall going into the heating season. If installing in spring or summer charge to 175 kPa.

After operating the machine for a period of time, any residual air in the system can be bled off through valved vertical standpipes in the pump module. If pressure drops below 175 kPa add additional water / antifreeze mix with the purge pump to bring the pressure back to the original setting.

NORDIC® Horizontal Trench Design

Closed loop Plastic Earthloop

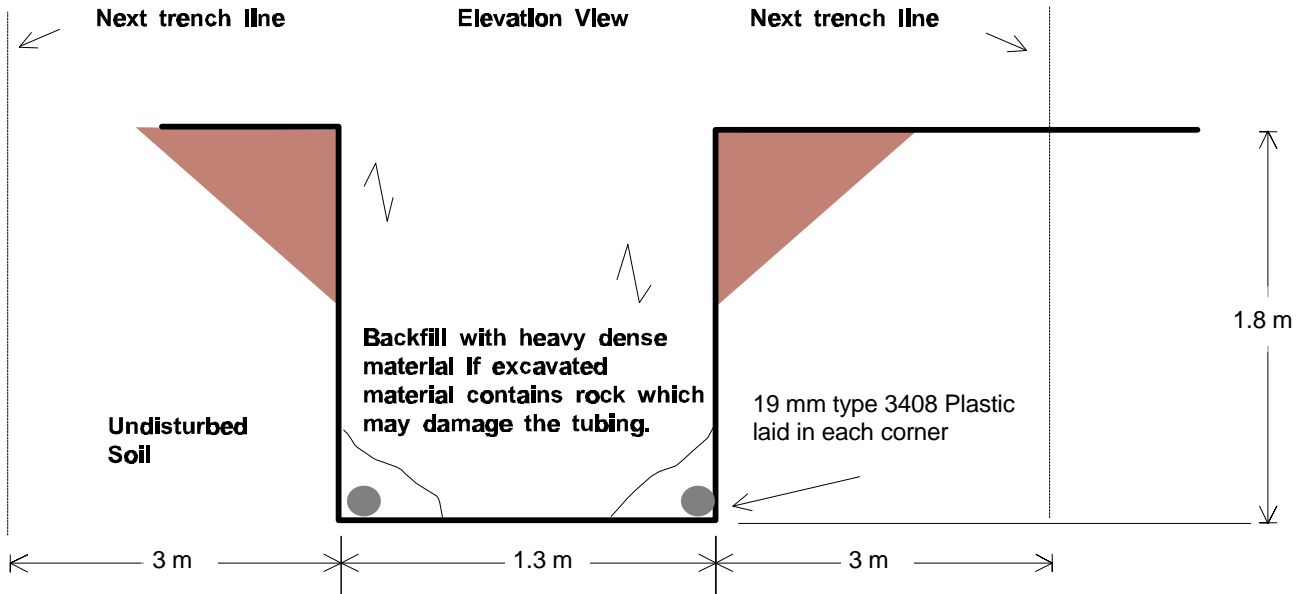

IMPORTANT NOTES:

Horizontal style pipe runs should be placed 1.8 m deep a minimum of 1.3 m wide trench as shown above. Hand backfilling in the area just over the plastic is recommended to prevent crushing or pinching the pipe during backfilling operations. Individual trenches (1 per ton) should be spaced a minimum of 3 m apart to allow the best performance of the ground field.

See additional diagrams for pump and piping information.

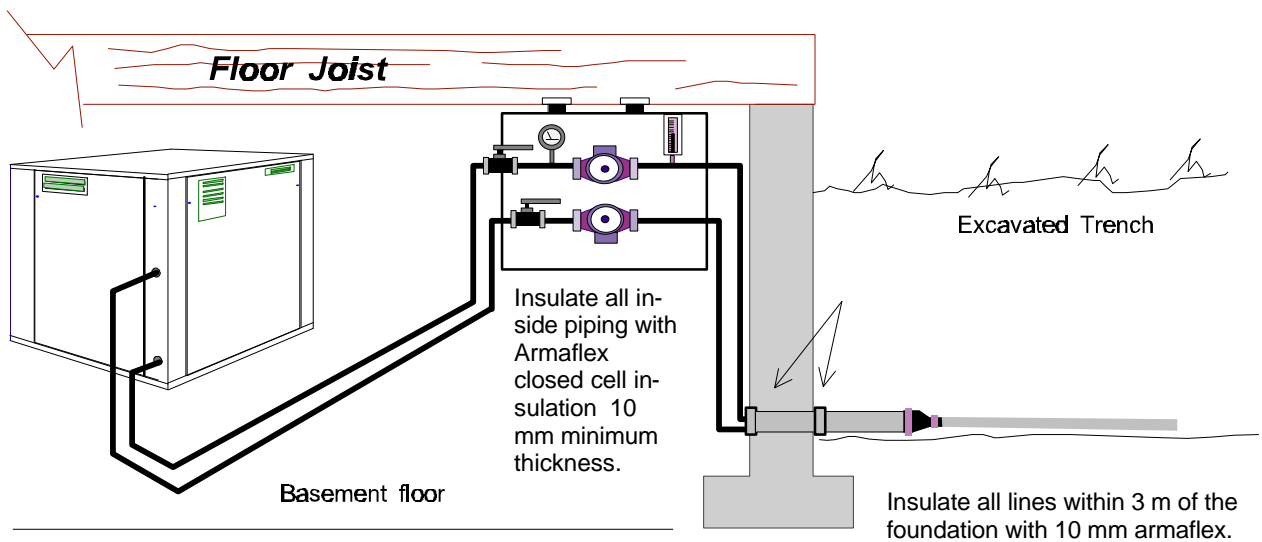

Interior Loop Pump 3-way Fill Valve Valve Assembly

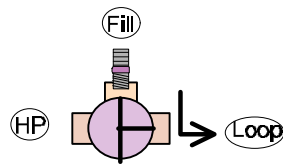
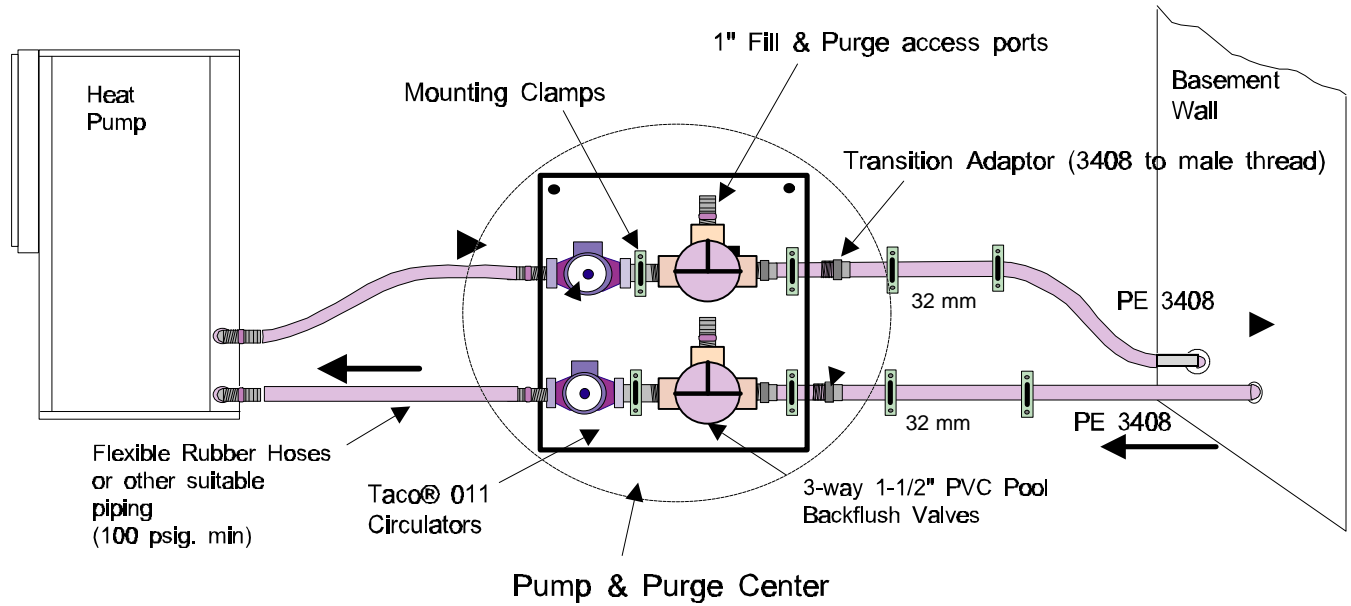

1. Valve in Loop fill/purge position.

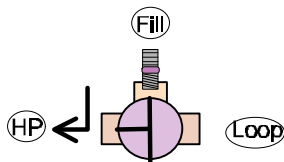

2. Valve in HP fill/purge position

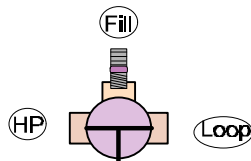

3. Valve in normal running position.

Maritime Geothermal Ltd.	
May 10/1999	3-way valves

Typical 3-4 and 5 Loop Parallel Header Design

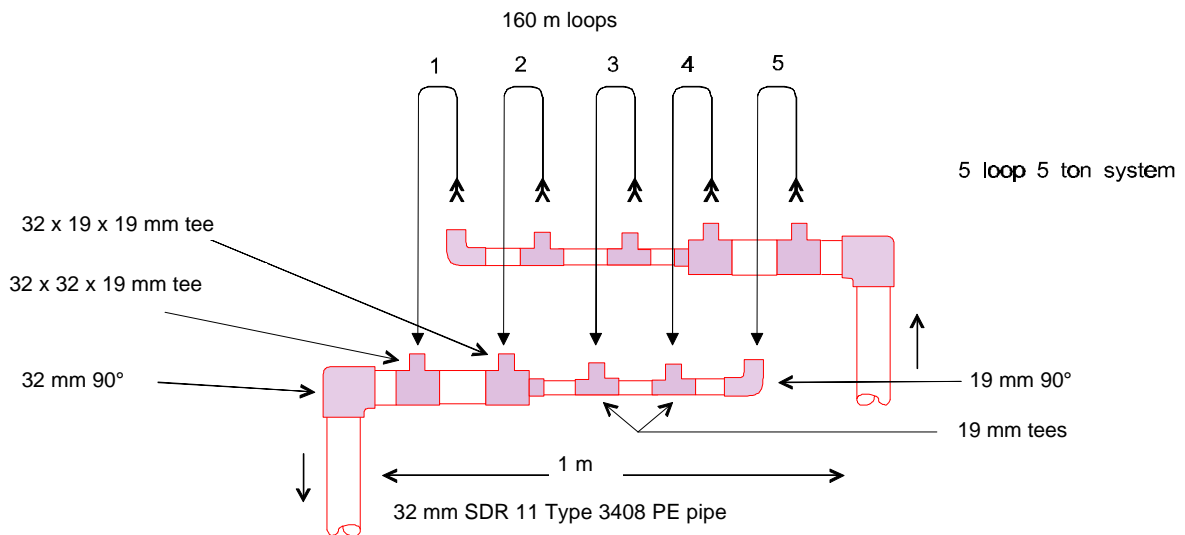
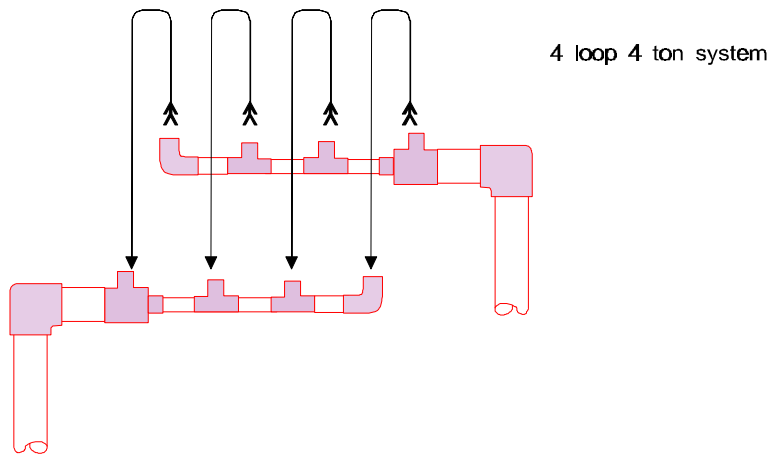
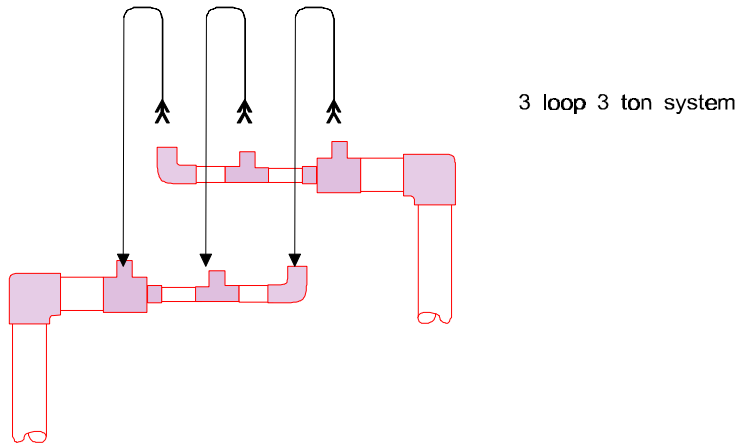

NORDIC® Series Wec-45-55-65-80-175

[Redacted]

[Redacted]

[Redacted]

[Redacted]

[Redacted]

Engineering and Performance Data

[Redacted]

[Redacted]

[Redacted]

[Redacted]

[Redacted]

June 1998

Maritime Geothermal Ltd.		Revision 4.0	Color: Caissie Grey
Liquid-to-Water Heat Pumps		Models: W-45-55-65	Style: Vertical
Date: June 1998	Drawn By: G. Kaye	Title: Cabinet Layout	

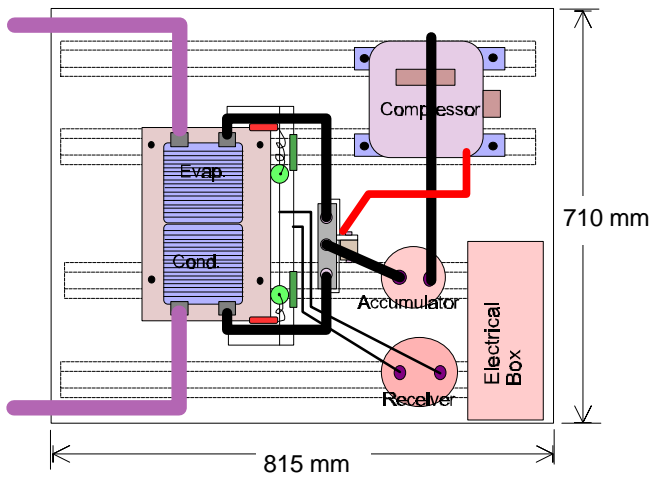

Top View

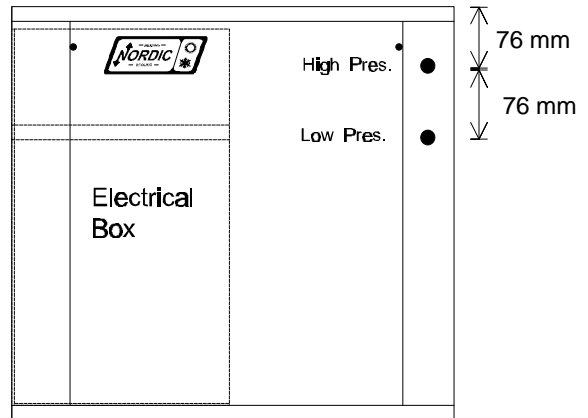

Back View

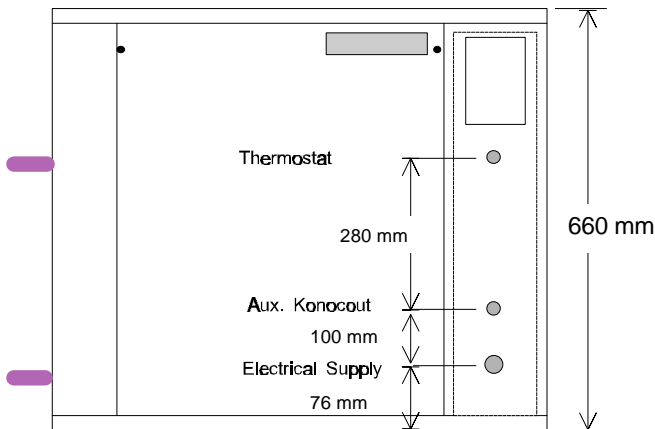

Right Side View

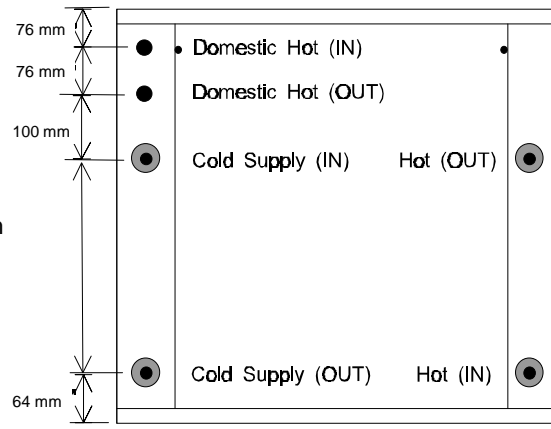

Front View

General Specifications

1. Case constructed of satin galvanized materials with epoxy latex enamel finish.
2. Type 316 copper brazed plate heat exchangers on both source and sink sides.
3. High Efficiency scroll or reciprocating heat pump compressor.
4. Liquid receiver and suction line accumulator .
5. Four removable doors and a removable top for easy access from any side
6. Acoustically insulated cabinet.
7. Optional domestic hot water heat exchanger.
8. All Copper piping throughout the heat pump.

Maritime Geothermal Ltd.		Revision 4.0	Color: Caissie Grey
Liquid-to-Water Heat Pumps		Models: W-45-55-65	Style: Horizontal
Date: June 1998	Drawn By: G. Kaye	Title: Component & Piping Layout	

- Domestic Hot Water (IN)
- Domestic Hot Water (OUT)
- Galvanized metal with baked enamel or epoxy based finish.
- **Supply water (IN)**
- Thermostatic expansion valves.
- High efficiency scroll compressors.
- **Supply water (OUT)**
- Suction accumulator.
- Double wall potable water desuperheater.
- Hot Water circulator
- High Efficiency brazed plate heat exchangers.
- Reversing Valve
- Liquid line filter drier.
- **HOT water (OUT)**
- Sight glass.
- Liquid receiver.
- **HOT water (IN)**
- Insulated water coils.

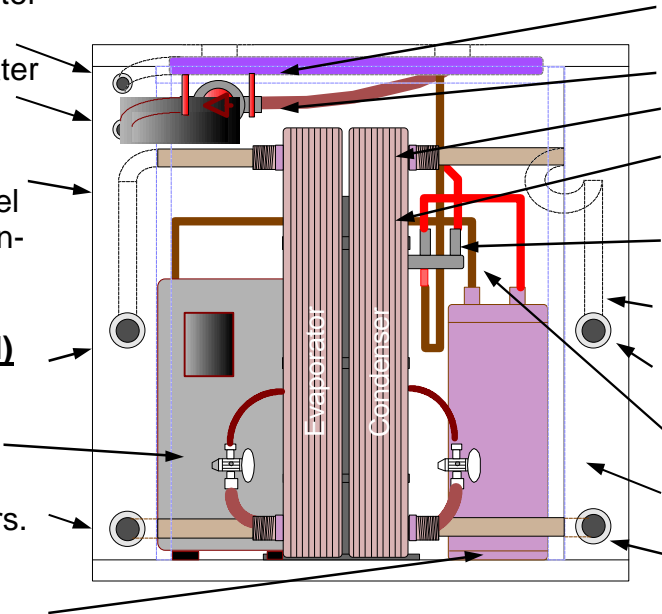

(Front) Plumbing side

- Baked enamel cabinet with satin galvanized condensate tray and floor.
- Components accessible from all four sides.
- Heavy duty electrical components.
- Hard start kit on all models single phase models.
- High & Low access ports.
- Remote reset lock-out relay system.
- Acoustically insulated cabinet.
- Cabinet spot welded together for superior strength.
- High efficiency scroll compressor.

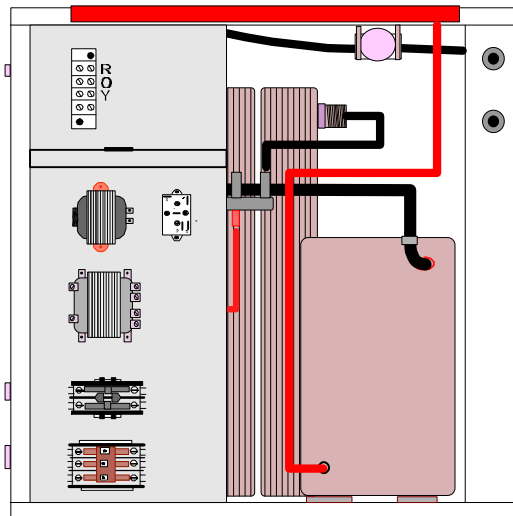

(Back) Electrical Box Side

W-HACW Series Refrigeration Circuit (Heating Mode)

Functions: Heating, Cooling & Domestic Hot Water

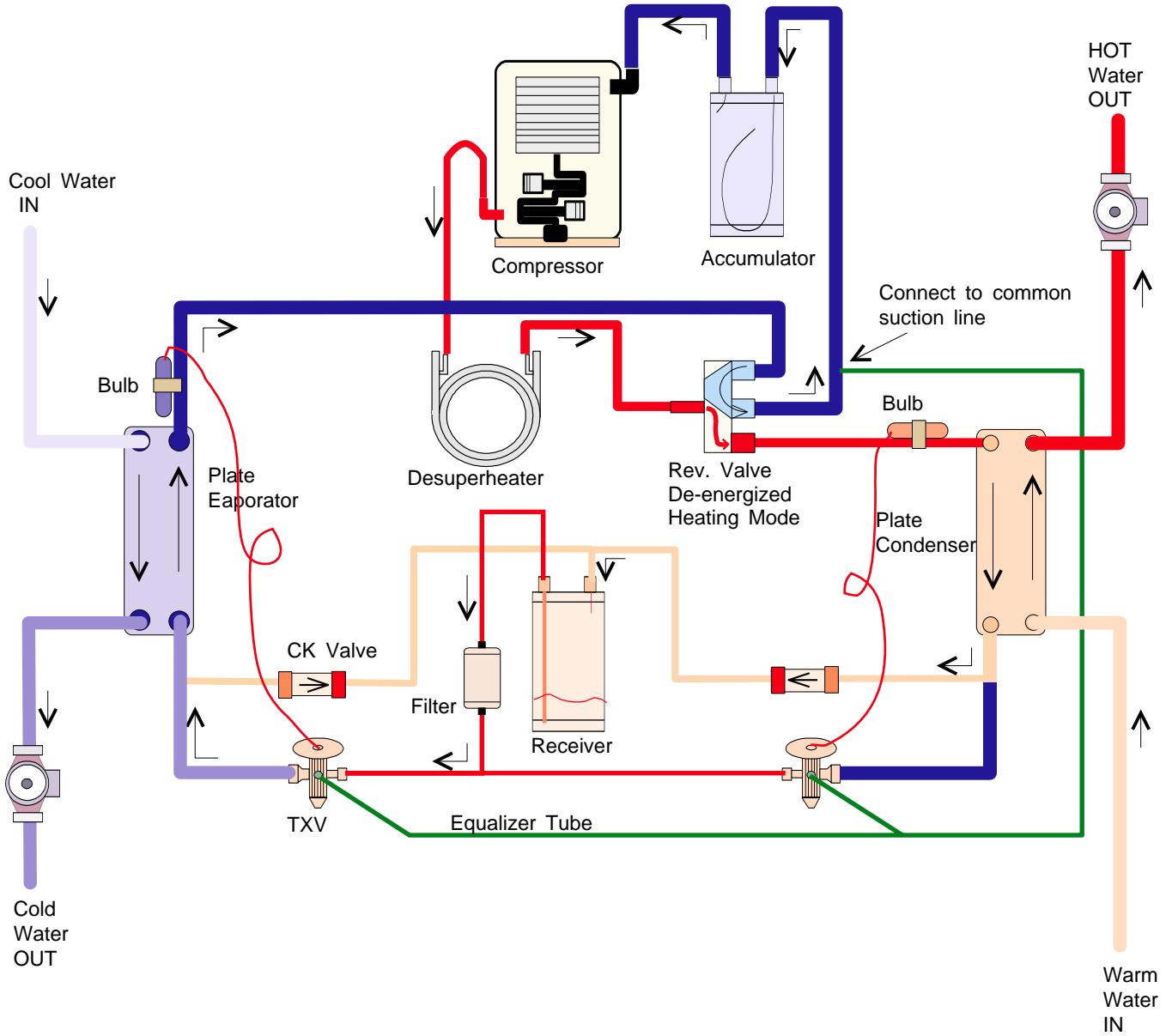

Maritime Geothermal Ltd.

Drawn By: Glenn Kaye

Water Flow Requirements in Litres/min (Condenser (HOT) Side)			
(LWT)°C - (EWT)°C	Wec-45 (35,000 Btu's)	Wec-55 (50,000 Btu's)	Wec-65 (60,000 Btu's)
13.9°C	10.45 (l/min)	15 (l/min.)	18.2 (l/min.)
11.1	13.2	19.1	22.7
8.3	17.7	25.5	30.5
5.55°C	26.4	37.7	45.5
2.8	52.7	75.5	91
1.7	88.2	126	151.4

NOTE: When selecting circulator pump sizes for the condenser side of a heat pump **for infloor heat use**, it is normal practice to limit the temperature rise to 5.6°C or less for the highest output temperature vs. refrigerant discharge pressure.

Equation

$$\text{Btu Output (Btu's/hr)} = (\text{L/min}) \times (2.2 \text{ lbs./litre}) \times (60 \text{ min/hr}) \times (\text{temp. diff. } ^\circ\text{C} \times 1.8)$$

Therefore for a W- 45 the temp rise across the heat exchanger would be:

$$\text{Igpm} = \frac{\text{(Btu/hr Output)}}{(\text{ } ^\circ\text{C temp. diff.} \times 1.8) \times (2.2 \text{ lbs./gal.}) \times (60 \text{ min/hr})} = \frac{35,000}{(10 \times 2.2 \times 60) \times 1320} = 26.51 \text{ L/min.}$$

Divide the BTU output of any water heat pump by 1320 yields the flow required at a temperature rise of 5.55°C from entering water temp (EWT) to leaving water temp (LWT).

Electrical Supply and Thermostat Wire Sizes @ 380v/3/50					
Model	Wec-45	Wec-55	Wec-65	Wec-80	Wec-175
BTU output @ W10°C/W50°C	35m (10.3 kw)	50m (15.4 kw)	60m (17.7 kw)	100m (30 kw)	150m (44 kw)
Min. circuit ampacity	9	11	13	22	33
Minimum wire size	# 14-4	# 14-4	# 14-4	# 10-4	# 6-4
Max. Fuse Size (Delay)	15	20	20	30	50
Max. breaker size	15	20	20	30	50
Thermostat wire size	# 18	# 18	# 18	#18	#18
Thermostat conductors	4	4	4	4	4

Brazed Plate Heat Exchanger —Water Flow Vs. Pressure drop Tables (kPa)			
(L/min)	Wec-45 (CB50-30)	Wec-55 (CB50-38)	Wec-65 (CB50-50)
53	42 (kPa)	26.6	16.1
45.4	31	19.9	11.9
37.9	22.1	14.1	8.5
30.3	14.5	9.2	5.5
22.7	8.4	5.3	3.17
15.1	3.7	2.4	1.44

W-45ec-HAC

Nominal 3 ton

Heating

Source Data						Power Consumption				Sink Data					
ELT °F	Evap. °F	Flow lgpm	LLT °F	Temp. Diff °F	HAB (Btu's)	Watts	Amps	Output (Btu's)	KW OUT	COP	EWT °F	lgpm	LWT °F	Delta °F	Cond. °F
°C	°C	L/min	°C	°C	tons			tons			°C	L/min	°C	°C	°C
27	15	8.0	23.2	3.79	18,204	2,707	5.0	27,441	8.0	2.97	105	8.0	110.7	5.7	120
-2.8	-9.4	36	-4.9	2.1	1.5			2.3			40.6	36	43.7	3.2	48.9
33	20	8.0	28.7	4.28	20,556	2,687	5.0	29,727	8.7	3.24	105	8.0	111.2	6.2	120
0.6	-6.7	36	-1.8	2.4	1.7			2.5			40.6	36	44.0	3.4	48.9
39	25	8.0	34.2	4.81	23,084	2,667	4.9	32,187	9.4	3.54	105	8.0	111.7	6.7	120
3.9	-3.9	36	1.2	2.7	1.9			2.7			40.6	36	44.3	3.7	48.9
45	30	8.0	39.6	5.37	25,793	2,647	4.9	34,828	10.2	3.85	105	8.0	112.3	7.3	120
7.2	-1.1	36	4.2	3.0	2.1			2.9			40.6	36	44.6	4.0	48.9
51	35	8.0	45.0	5.98	28,688	2,628	4.9	37,658	11.0	4.20	105	8.0	112.8	7.8	120
10.6	1.7	36	7.2	3.3	2.4			3.1			40.6	36	44.9	4.4	48.9
57	40	8.0	50.4	6.62	31,773	2,611	4.9	40,685	11.9	4.57	105	8.0	113.5	8.5	120
13.9	4.4	36	10.2	3.7	2.6			3.4			40.6	36	45.3	4.7	48.9
63	45	8.0	55.7	7.30	35,056	2,596	4.8	43,916	12.9	4.96	105	8.0	114.1	9.1	120
17.2	7.2	36	13.2	4.1	2.9			3.7			40.6	36	45.6	5.1	48.9
69	50	8.0	61.0	8.03	38,539	2,584	4.8	47,359	13.9	5.37	105	8.0	114.9	9.9	120
20.6	10.0	36	16.1	4.5	3.2			3.9			40.6	36	46.0	5.5	48.9

ZR40K3-TFD 380 50 3phase Model

W-45ec-HAC

Nominal 3 ton

Cooling

Source Data						Power Consumption				Sink Data					
ELT °F	Evap. °F	Flow lgpm	LLT °F	Temp. Diff °F	HAB (Btu's)	Watts	Amps	Output (Btu's)	KW OUT	EER	EWT °F	lgpm	LWT °F	Delta °F	Cond. °F
°C	°C	L/min	°C	°C	tons			tons			°C	L/min	°C	°C	°C
52	40	8.0	43.9	8.09	38,826	1,577	3.6	44,208	13.0	24.62	65	8.0	74.2	9.2	80
11.1	4.4	36	6.6	4.5	3.2			3.7			18.3	36	23.5	5.1	26.7
52	40	8.0	44.1	7.91	37,987	1,682	3.7	43,728	12.8	22.58	70	8.0	79.1	9.1	85
11.1	4.4	36	6.7	4.4	3.2			3.6			21.1	36	26.2	5.1	29.4
52	40	8.0	44.3	7.74	37,138	1,793	3.9	43,256	12.7	20.72	75	8.0	84.0	9.0	90
11.1	4.4	36	6.8	4.3	3.1			3.6			23.9	36	28.9	5.0	32.2
52	40	8.0	44.4	7.56	36,276	1,909	4.0	42,792	12.5	19.00	80	8.0	88.9	8.9	95
11.1	4.4	36	6.9	4.2	3.0			3.6			26.7	36	31.6	5.0	35.0
52	40	8.0	44.6	7.38	35,403	2,033	4.1	42,340	12.4	17.42	85	8.0	93.8	8.8	100
11.1	4.4	36	7.0	4.1	3.0			3.5			29.4	36	34.3	4.9	37.8
52	40	8.0	44.8	7.19	34,516	2,164	4.3	41,902	12.3	15.95	90	8.0	98.7	8.7	105
11.1	4.4	36	7.1	4.0	2.9			3.5			32.2	36	37.1	4.8	40.6
52	40	8.0	45.0	7.00	33,616	2,304	4.5	41,478	12.2	14.59	95	8.0	103.6	8.6	110
11.1	4.4	36	7.2	3.9	2.8			3.5			35.0	36	39.8	4.8	43.3
52	40	8.0	45.2	6.81	32,702	2,452	4.7	41,072	12.0	13.34	100	8.0	108.6	8.6	115
11.1	4.4	36	7.3	3.8	2.7			3.4			37.8	36	42.5	4.8	46.1

ZR40K3-TFD 380 50 3phase Model

W-55ec-HAC

Nominal 4 ton

Heating

Source Data						Power Consumption				Sink Data					
ELT °F	Evap. °F	Flow lgpm	LLT °F	Temp. Diff °F	HAB (Btu's)	Watts	Amps	Output (Btu's)	KW OUT	COP	EWT °F	lgpm	LWT °F	Delta °F	Cond. °F
°C	°C	L/min	°C	°C	tons			tons			°C	L/min	°C	°C	°C
27	15	10.0	22.8	4.20	25,208	3,754	6.7	38,021	11.1	2.97	105	10.0	111.3	6.3	120
-2.8	-9.4	45	-5.1	2.3	2.1			3.2			40.6	45	44.1	3.5	48.9
33	20	10.0	28.2	4.77	28,645	3,727	6.7	41,364	12.1	3.25	105	10.0	111.9	6.9	120
0.6	-6.7	45	-2.1	2.7	2.4			3.4			40.6	45	44.4	3.8	48.9
39	25	10.0	33.6	5.39	32,354	3,700	6.6	44,983	13.2	3.56	105	10.0	112.5	7.5	120
3.9	-3.9	45	0.9	3.0	2.7			3.7			40.6	45	44.7	4.2	48.9
45	30	10.0	38.9	6.06	36,336	3,675	6.6	48,880	14.3	3.90	105	10.0	113.1	8.1	120
7.2	-1.1	45	3.9	3.4	3.0			4.1			40.6	45	45.1	4.5	48.9
51	35	10.0	44.2	6.77	40,592	3,652	6.6	53,057	15.5	4.26	105	10.0	113.8	8.8	120
10.6	1.7	45	6.8	3.8	3.4			4.4			40.6	45	45.5	4.9	48.9
57	40	10.0	49.5	7.52	45,124	3,631	6.5	57,518	16.9	4.64	105	10.0	114.6	9.6	120
13.9	4.4	45	9.7	4.2	3.8			4.8			40.6	45	45.9	5.3	48.9
63	45	10.0	54.7	8.32	49,935	3,612	6.5	62,264	18.2	5.05	105	10.0	115.4	10.4	120
17.2	7.2	45	12.6	4.6	4.2			5.2			40.6	45	46.3	5.8	48.9
69	50	10.0	59.8	9.17	55,027	3,595	6.5	67,297	19.7	5.48	105	10.0	116.2	11.2	120
20.6	10.0	45	15.5	5.1	4.6			5.6			40.6	45	46.8	6.2	48.9

ZR57K3-TFD 380 50 3phase Model

W-55ec-HAC

Nominal 4 ton

Cooling

Source Data						Power Consumption				Sink Data					
ELT °F	Evap. °F	Flow lgpm	LLT °F	Temp. Diff °F	HAB (Btu's)	Watts	Amps	Output (Btu's)	KW OUT	EER	EWT °F	lgpm	LWT °F	Delta °F	Cond. °F
°C	°C	L/min	°C	°C	tons			tons			°C	L/min	°C	°C	°C
52	40	10.0	42.7	9.26	55,537	2,172	4.6	62,950	18.4	25.57	65	10.0	75.5	10.5	80
11.1	4.4	45	6.0	5.1	4.6			5.2			18.3	45	24.2	5.8	26.7
52	40	10.0	43.0	9.04	54,243	2,325	4.8	62,180	18.2	23.33	70	10.0	80.4	10.4	85
11.1	4.4	45	6.1	5.0	4.5			5.2			21.1	45	26.9	5.8	29.4
52	40	10.0	43.2	8.83	52,962	2,483	5.0	61,437	18.0	21.33	75	10.0	85.2	10.2	90
11.1	4.4	45	6.2	4.9	4.4			5.1			23.9	45	29.6	5.7	32.2
52	40	10.0	43.4	8.61	51,685	2,648	5.2	60,722	17.8	19.52	80	10.0	90.1	10.1	95
11.1	4.4	45	6.3	4.8	4.3			5.1			26.7	45	32.3	5.6	35.0
52	40	10.0	43.6	8.40	50,406	2,820	5.4	60,032	17.6	17.87	85	10.0	95.0	10.0	100
11.1	4.4	45	6.4	4.7	4.2			5.0			29.4	45	35.0	5.6	37.8
52	40	10.0	43.8	8.19	49,118	3,003	5.7	59,368	17.4	16.35	90	10.0	99.9	9.9	105
11.1	4.4	45	6.6	4.5	4.1			4.9			32.2	45	37.7	5.5	40.6
52	40	10.0	44.0	7.97	47,813	3,198	5.9	58,729	17.2	14.95	95	10.0	104.8	9.8	110
11.1	4.4	45	6.7	4.4	4.0			4.9			35.0	45	40.4	5.4	43.3
52	40	10.0	44.3	7.75	46,484	3,407	6.2	58,112	17.0	13.64	100	10.0	109.7	9.7	115
11.1	4.4	45	6.8	4.3	3.9			4.8			37.8	45	43.2	5.4	46.1

ZR57K3-TFD 380 50 3phase Model

W-65ec-HAC

Nominal 5 ton

Heating

Source Data						Power Consumption				Sink Data					
ELT °F	Evap. °F	Flow lgpm	LLT °F	Temp. Diff °F	HAB (Btu's)	Watts	Amps	Output (Btu's)	KW OUT	COP	EWT °F	lgpm	LWT °F	Delta °F	Cond. °F
°C	°C	L/min	°C	°C	tons			tons			°C	L/min	°C	°C	°C
27	15	12.0	22.6	4.38	31,564	4,430	7.8	46,682	13.7	3.09	105	12.0	111.5	6.5	120
-2.8	-9.4	54	-5.2	2.4	2.6			3.9			40.6	54	44.2	3.6	48.9
33	20	12.0	28.1	4.92	35,435	4,415	7.8	50,505	14.8	3.35	105	12.0	112.0	7.0	120
0.6	-6.7	54	-2.2	2.7	3.0			4.2			40.6	54	44.5	3.9	48.9
39	25	12.0	33.5	5.50	39,586	4,405	7.8	54,622	16.0	3.63	105	12.0	112.6	7.6	120
3.9	-3.9	54	0.8	3.1	3.3			4.6			40.6	54	44.8	4.2	48.9
45	30	12.0	38.9	6.12	44,039	4,400	7.8	59,056	17.3	3.93	105	12.0	113.2	8.2	120
7.2	-1.1	54	3.8	3.4	3.7			4.9			40.6	54	45.1	4.6	48.9
51	35	12.0	44.2	6.78	48,820	4,398	7.8	63,832	18.7	4.25	105	12.0	113.9	8.9	120
10.6	1.7	54	6.8	3.8	4.1			5.3			40.6	54	45.5	4.9	48.9
57	40	12.0	49.5	7.49	53,951	4,401	7.8	68,973	20.2	4.59	105	12.0	114.6	9.6	120
13.9	4.4	54	9.7	4.2	4.5			5.7			40.6	54	45.9	5.3	48.9
63	45	12.0	54.7	8.26	59,456	4,409	7.8	74,503	21.8	4.95	105	12.0	115.3	10.3	120
17.2	7.2	54	12.6	4.6	5.0			6.2			40.6	54	46.3	5.7	48.9
69	50	12.0	59.9	9.08	65,360	4,420	7.8	80,446	23.6	5.33	105	12.0	116.2	11.2	120
20.6	10.0	54	15.5	5.0	5.4			6.7			40.6	54	46.8	6.2	48.9

ZR68KC-TFD 380 50 3phase Model

W-65ec-HAC

Nominal 5 ton

Cooling

Source Data						Power Consumption				Sink Data					
ELT °F	Evap. °F	Flow lgpm	LLT °F	Temp. Diff °F	HAB (Btu's)	Watts	Amps	Output (Btu's)	KW OUT	EER	EWT °F	lgpm	LWT °F	Delta °F	Cond. °F
°C	°C	L/min	°C	°C	tons			tons			°C	L/min	°C	°C	°C
52	40	12.0	42.9	9.08	65,389	2,778	5.7	74,869	21.9	23.54	65	12.0	75.4	10.4	80
11.1	4.4	54	6.1	5.0	5.4			6.2			18.3	54	24.1	5.8	26.7
52	40	12.0	43.1	8.88	63,910	2,928	5.9	73,904	21.7	21.82	70	12.0	80.3	10.3	85
11.1	4.4	54	6.2	4.9	5.3			6.2			21.1	54	26.8	5.7	29.4
52	40	12.0	43.3	8.68	62,478	3,093	6.1	73,035	21.4	20.20	75	12.0	85.1	10.1	90
11.1	4.4	54	6.3	4.8	5.2			6.1			23.9	54	29.5	5.6	32.2
52	40	12.0	43.5	8.48	61,076	3,272	6.3	72,245	21.2	18.66	80	12.0	90.0	10.0	95
11.1	4.4	54	6.4	4.7	5.1			6.0			26.7	54	32.2	5.6	35.0
52	40	12.0	43.7	8.29	59,689	3,466	6.6	71,520	21.0	17.22	85	12.0	94.9	9.9	100
11.1	4.4	54	6.5	4.6	5.0			6.0			29.4	54	35.0	5.5	37.8
52	40	12.0	43.9	8.10	58,300	3,676	6.8	70,845	20.8	15.86	90	12.0	99.8	9.8	105
11.1	4.4	54	6.6	4.5	4.9			5.9			32.2	54	37.7	5.5	40.6
52	40	12.0	44.1	7.90	56,891	3,901	7.1	70,206	20.6	14.58	95	12.0	104.8	9.8	110
11.1	4.4	54	6.7	4.4	4.7			5.9			35.0	54	40.4	5.4	43.3
52	40	12.0	44.3	7.70	55,447	4,143	7.5	69,587	20.4	13.38	100	12.0	109.7	9.7	115
11.1	4.4	54	6.8	4.3	4.6			5.8			37.8	54	43.1	5.4	46.1

ZR68KC-TFD 380 50 3phase Model

W-80ec-HAC

Nominal 8 ton

Heating

Source Data						Power Consumption				Sink Data					
ELT °F	Evap. °F	Flow lgpm	LLT °F	Temp. Diff °F	HAB (Btu's)	Watts	Amps	Output (Btu's)	KW OUT	COP	EWT °F	lgpm	LWT °F	Delta °F	Cond. °F
°C	°C	L/min	°C	°C	tons			tons			°C	L/min	°C	°C	°C
27	15	20.0	22.8	4.20	50,399	7,051	13.3	74,465	21.8	3.09	105	20.0	111.2	6.2	120
-2.8	-9.4	90	-5.1	2.3	4.2			6.2			40.6	90	44.0	3.4	48.9
33	20	20.0	28.3	4.72	56,664	7,074	13.3	80,807	23.7	3.35	105	20.0	111.7	6.7	120
0.6	-6.7	90	-2.1	2.6	4.7			6.7			40.6	90	44.3	3.7	48.9
39	25	20.0	33.7	5.28	63,347	7,086	13.3	87,530	25.6	3.62	105	20.0	112.3	7.3	120
3.9	-3.9	90	1.0	2.9	5.3			7.3			40.6	90	44.6	4.1	48.9
45	30	20.0	39.1	5.87	70,496	7,088	13.3	94,688	27.7	3.91	105	20.0	112.9	7.9	120
7.2	-1.1	90	4.0	3.3	5.9			7.9			40.6	90	44.9	4.4	48.9
51	35	20.0	44.5	6.51	78,160	7,084	13.3	102,339	30.0	4.23	105	20.0	113.5	8.5	120
10.6	1.7	90	6.9	3.6	6.5			8.5			40.6	90	45.3	4.7	48.9
57	40	20.0	49.8	7.20	86,389	7,075	13.3	110,538	32.4	4.58	105	20.0	114.2	9.2	120
13.9	4.4	90	9.9	4.0	7.2			9.2			40.6	90	45.7	5.1	48.9
63	45	20.0	55.1	7.94	95,232	7,064	13.3	119,340	35.0	4.95	105	20.0	114.9	9.9	120
17.2	7.2	90	12.8	4.4	7.9			9.9			40.6	90	46.1	5.5	48.9
69	50	20.0	60.3	8.73	104,736	7,052	13.3	128,803	37.7	5.35	105	20.0	115.7	10.7	120
20.6	10.0	90	15.7	4.8	8.7			10.7			40.6	90	46.5	6.0	48.9

ZR11M3-TWD 400 50 3phase

W-80ec-HAC

Nominal 8 ton

Cooling

Source Data						Power Consumption				Sink Data					
ELT °F	Evap. °F	Flow lgpm	LLT °F	Temp. Diff °F	HAB (Btu's)	Watts	Amps	Output (Btu's)	KW OUT	EER	EWT °F	lgpm	LWT °F	Delta °F	Cond. °F
°C	°C	L/min	°C	°C	tons			tons			°C	L/min	°C	°C	°C
52	40	20.0	43.3	8.74	104,823	4,444	10.5	119,993	35.2	23.59	65	20.0	75.0	10.0	80
11.1	4.4	90	6.3	4.9	8.7			10.0			18.3	90	23.9	5.6	26.7
52	40	20.0	43.4	8.56	102,756	4,703	10.7	118,808	34.8	21.85	70	20.0	79.9	9.9	85
11.1	4.4	90	6.4	4.8	8.6			9.9			21.1	90	26.6	5.5	29.4
52	40	20.0	43.6	8.38	100,611	4,981	11.0	117,613	34.5	20.20	75	20.0	84.8	9.8	90
11.1	4.4	90	6.5	4.7	8.4			9.8			23.9	90	29.3	5.4	32.2
52	40	20.0	43.8	8.20	98,394	5,279	11.3	116,412	34.1	18.64	80	20.0	89.7	9.7	95
11.1	4.4	90	6.6	4.6	8.2			9.7			26.7	90	32.1	5.4	35.0
52	40	20.0	44.0	8.01	96,109	5,597	11.6	115,212	33.8	17.17	85	20.0	94.6	9.6	100
11.1	4.4	90	6.7	4.4	8.0			9.6			29.4	90	34.8	5.3	37.8
52	40	20.0	44.2	7.81	93,762	5,935	12.0	114,019	33.4	15.80	90	20.0	99.5	9.5	105
11.1	4.4	90	6.8	4.3	7.8			9.5			32.2	90	37.5	5.3	40.6
52	40	20.0	44.4	7.61	91,356	6,294	12.4	112,838	33.1	14.51	95	20.0	104.4	9.4	110
11.1	4.4	90	6.9	4.2	7.6			9.4			35.0	90	40.2	5.2	43.3
52	40	20.0	44.6	7.41	88,897	6,674	12.8	111,676	32.7	13.32	100	20.0	109.3	9.3	115
11.1	4.4	90	7.0	4.1	7.4			9.3			37.8	90	42.9	5.2	46.1

ZR11M3-TWD 400 50 3phase

W-175ec-HAC

Nominal 12 ton

Heating

Source Data						Power Consumption				Sink Data					
ELT °F	Evap. °F	Flow lgpm	LLT °F	Temp. Diff °F	HAB (Btu's)	Watts	Amps	Output (Btu's)	KW OUT	COP	EWT °F	Igpm	LWT °F	Delta °F	Cond. °F
°C	°C	L/min	°C	°C	tons			tons			°C	L/min	°C	°C	°C
27	15	25.0	22.2	4.75	71,290	9,922	15.8	105,154	30.8	3.11	105	25.0	112.0	7.0	120
-2.8	-9.4	113	-5.4	2.6	5.9			8.8			40.6	113	44.5	3.9	48.9
33	20	25.0	27.6	5.37	80,508	9,968	15.8	114,528	33.6	3.37	105	25.0	112.6	7.6	120
0.6	-6.7	113	-2.4	3.0	6.7			9.5			40.6	113	44.8	4.2	48.9
39	25	25.0	33.0	6.01	90,219	9,996	15.8	124,334	36.4	3.64	105	25.0	113.3	8.3	120
3.9	-3.9	113	0.5	3.3	7.5			10.4			40.6	113	45.2	4.6	48.9
45	30	25.0	38.3	6.70	100,504	10,010	15.8	134,668	39.5	3.94	105	25.0	114.0	9.0	120
7.2	-1.1	113	3.5	3.7	8.4			11.2			40.6	113	45.5	5.0	48.9
47	35	25.0	39.6	7.43	111,447	10,014	15.8	145,626	42.7	11.13	105	25.0	114.7	9.7	120
8.3	1.7	113	4.2	4.1	9.3			12.1			40.6	113	45.9	5.4	48.9
52	40	25.0	43.8	8.21	123,130	10,013	15.8	157,303	46.1	12.30	105	25.0	115.5	10.5	120
11.1	4.4	113	6.6	4.6	10.3			13.1			40.6	113	46.4	5.8	48.9
57	45	25.0	48.0	9.04	135,638	10,008	15.8	169,795	49.7	13.55	105	25.0	116.3	11.3	120
13.9	7.2	113	8.9	5.0	11.3			14.1			40.6	113	46.8	6.3	48.9
62	50	25.0	52.1	9.94	149,052	10,004	15.8	183,197	53.7	14.90	105	25.0	117.2	12.2	120
16.7	10.0	113	11.1	5.5	12.4			15.3			40.6	113	47.3	6.8	48.9

ZR16M3-TWD 400 50 3phase

W-175ec-HAC

Nominal 12 ton

Cooling

Source Data						Power Consumption				Sink Data					
ELT °F	Evap. °F	Flow lgpm	LLT °F	Temp. Diff °F	HAB (Btu's)	Watts	Amps	Output (Btu's)	KW OUT	EER	EWT °F	Igpm	LWT °F	Delta °F	Cond. °F
°C	°C	L/min	°C	°C	tons			tons			°C	L/min	°C	°C	°C
52	40	25.0	42.1	9.88	148,144	6,709	12.1	171,043	50.1	22.08	65	25.0	76.4	11.4	80
11.1	4.4	113	5.6	5.5	12.3			14.3			18.3	113	24.7	6.3	26.7
52	40	25.0	42.3	9.69	145,300	6,996	12.4	169,178	49.6	20.77	70	25.0	81.3	11.3	85
11.1	4.4	113	5.7	5.4	12.1			14.1			21.1	113	27.4	6.3	29.4
52	40	25.0	42.5	9.49	142,397	7,318	12.8	167,373	49.0	19.46	75	25.0	86.2	11.2	90
11.1	4.4	113	5.8	5.3	11.9			13.9			23.9	113	30.1	6.2	32.2
52	40	25.0	42.7	9.29	139,422	7,675	13.2	165,619	48.5	18.16	80	25.0	91.0	11.0	95
11.1	4.4	113	5.9	5.2	11.6			13.8			26.7	113	32.8	6.1	35.0
52	40	25.0	42.9	9.09	136,368	8,069	13.6	163,907	48.0	16.90	85	25.0	95.9	10.9	100
11.1	4.4	113	6.1	5.1	11.4			13.7			29.4	113	35.5	6.1	37.8
52	40	25.0	43.1	8.88	133,222	8,499	14.1	162,228	47.5	15.68	90	25.0	100.8	10.8	105
11.1	4.4	113	6.2	4.9	11.1			13.5			32.2	113	38.2	6.0	40.6
52	40	25.0	43.3	8.66	129,974	8,966	14.6	160,574	47.0	14.50	95	25.0	105.7	10.7	110
11.1	4.4	113	6.3	4.8	10.8			13.4			35.0	113	40.9	5.9	43.3
52	40	25.0	43.6	8.44	126,613	9,470	15.2	158,935	46.6	13.37	100	25.0	110.6	10.6	115
11.1	4.4	113	6.4	4.7	10.6			13.2			37.8	113	43.7	5.9	46.1

ZR16M3-TWD 400 50 3phase

NORDIC® W-Series Trouble Shooting Guide

Fault	Possible Cause	Verification	Recommended Action
<u>COMPRESSOR</u> Compressor not operating	Power Failure	Electric circuit test shows no voltage on the line side of compressor contactor.	Check for blown fuse at heat pump's disconnect box or blown fuse
	Disconnect switch open	Voltmeter shows no voltage on the line side of the compressor contactor.	Determine why the disconnect switch was opened, if all is OK close the switch.
	Fuse blown	At heat pump disconnect box, voltmeter shows voltage on the line side but not on the load side.	Replace fuse with proper size and type. (Time-delay) type "D" Check total load on system.
	Low voltage	Voltmeter shows abnormally low voltage (Below 210 v) at heat pump disconnect switch.	Call power company.
	Burned out motor	Ohmmeter shows no resistance between common and run terminals or between common and start terminals. Note: Be sure compressor overload has had a chance to reset. If comp. is hot this may take several hours.	Determine cause and replace motor.
	Thermal overload on compressor tripped.	Ohmmeter shows reading when placed across R and S terminals and infinity between C & R or C & S. Make sure the internal overload has had time to reset.	If windings are open or overload is faulty, replace compressor.
	Faulty compressor contactor.	Voltage on line side with contactor held closed, but no voltage on one or both terminals on the load side. Points pitted or burned.	Replace contactor.
	Seized compressor due to locked or damaged mechanism.	Compressor attempts to start but trips it's internal overload after a few seconds.	Attempt to "rock" compressor free. If normal operation cannot be established, replace compressor.
	Faulty run capacitor.	Check with ohmmeter for shorts, open etc.	Replace if faulty.

Fault	Possible Cause	Verification	Recommended Action
<i>(cont)</i> Compressor not operating	Open control circuit.	<ul style="list-style-type: none"> • Thermostat not calling for heat. • High or low pressure limit open. • Lock-out relay energized. 	Locate open control and determine cause. Replace faulty control if necessary.
Compressor “short cycles”	Intermittent contact in electrical control circuit.	Normal operation except too frequent starting and stopping.	Check for loose wiring. Check differential setting on aquastat. Widen setting to allow longer run cycles.
	Compressor over-loaded.	Check for continuity through internal overload in compressor.	Observe suction & discharge pressures – make sure amp draw is within range.
<u>HEATING MODE</u> Unit trips off on “LOW” suction pressure control.	Low or no evaporator water flow.	Manually open water valve (if equipped) and measure water flow with a flowmeter.	Check well pump or circ. pump for proper operation. Check water valve for proper operation.
	Evaporator water supply too cold.	Measure temperature of water. Check flow rate with spec. sheet to determine if proper gpm is available.	Increase flow to proper gpm for temperature of water used.
	Faulty low pressure ctrl.	Refrigerant pressure control should open on drop at approx. 310 kPa for well operation and 240 kPa for closed loop application.	The low control should reset automatically when refrigerant pressure reaches 450 to 485 kPa. Heat pump can then be restarted by resetting the lock-out relay. (Turn power off then back on) Replace faulty control if it will not reset.
	Low refrigerant charge.	Check water temp. and flow. Clean heat exchanger. If suction is still low check suction gas pres. Normal suction is 345-415 (380 typical) on R-22 or R-407C	Add refrigerant slowly until sight glass clears. Install fluorescent dye and check for possible leaks with ultra violet light, halide leak detector etc..
Unit trips off on “HIGH” pres. control.	Low or no condensing water flow. TXV stuck closed Filter drier plugged.	Check condenser flow with flowmeter. Check for refrigerant flow through TXV and filter.	Check circulator pump operation. Check operation of condenser refrigerant water flow valve. Replace filter or TXV if required.

Fault	Possible Cause	Verification	Recommended Action
<u>COOLING MODE</u> Low "temperature sensor" opens.	Low or no water flow on <u>evaporator</u> side. (Note: The function of the two heat exchangers are reversed when in cooling mode. Evap. Becomes cond. / cond. Becomes evaporator.)	Check fluid flow, strainers, pumps and valves in the system. Temp. ctrl. will open in about 1 minute if water flow is interrupted or if unit is run with suction pressure below 345 kPa.	Restore proper flow and temperature. Reset lock-out relay. Replace low suction temp. thermostat.
	Aquastat on cold buffer tank set too low. Should be 6.1 – 7.2°C	Verify accuracy of aquastat with reliable hand held thermometer.	Replace or readjust aquastat for proper operation.
High Pressure limit opens.	Low water flow on <u>condenser</u> side	Check flow of well water or loop water. Check for air or strainer restrictions. Water valves open.	Restore flow and reset lock-out relay.
	TXV possibly not opening. Liquid line possibly plugged.	Warm bulb with hand and observe suction pressure while operating.	Replace TXV or filter-drier if non operational or plugged.
<u>DOMESTIC HOT WATER</u> Insufficient hot water.	Circulator pump not operating.	Use an amprobe to measure current draw.	Replace if faulty.
	Blockage or restriction in the water line or hot water heat exchanger.	Check water flow and power to pump. Check water lines for obstruction	Remove obstruction in water lines. Acid treat the domestic hot water coil.
	Thermostat limit is open.	Check contact operation. Should close at 49°C and open at 57°C.	Replace thermostat if faulty.
<u>Domestic Hot Water Storage Tank</u> not maintaining at least 49°C.	Disconnect switch open, or fuse blown in electrical supply to hot water tank.	Check both line and load sides of fuses. If switch is open determine why.	Replace blown fuse or breaker or close switch.
	Reset button tripped on hot water tank.	Check voltage at elements with multimeter.	Push reset button.
	Thermostat on hot water tank set too low. Should be set at 49°C.	Visually inspect the setting.	Readjust the setting to 49°C.
	Heat pump not running enough hours to make sufficient hot water.	Note the amount of time the heat pump runs in any given hour.	Temporarily turn up the tank thermostats until colder weather creates longer run cycles.

Maritime Geothermal Ltd.		Revision 4.3	EC Model
Liquid-to-Liquid Heat Pumps		Models: Wec-45-175	380 / 3 / 50
Date: June 1998	Drawn By: G. Kaye	Title: Schematic Diagram	

Maritime Geothermal Ltd. NORDIC W-HW**

380/3/50 Unit Schematic Diagram H,HW,HAC,HACW

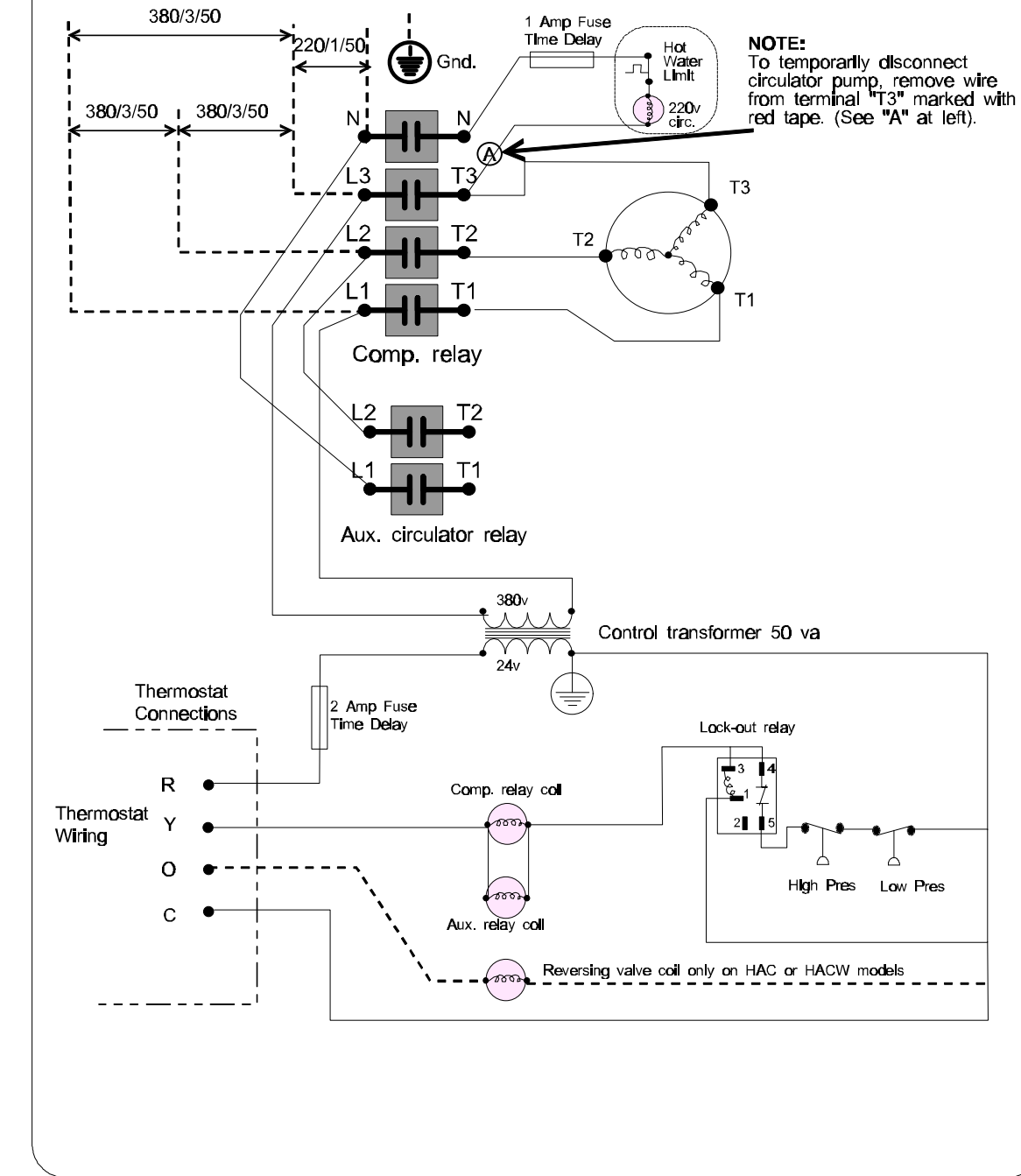

Maritime Geothermal Ltd.		Revision 4.3	EC Model
Liquid-to-Liquid Heat Pumps		Models: W-45-55-65	380 / 3 / 50
Date: June 1998	Drawn By: G.Kaye	Title: Electrical Box Connections	

Maritime Geothermal Ltd. NORDIC W-HACW

380v/3Ph/50Hz. Models - Field Wiring

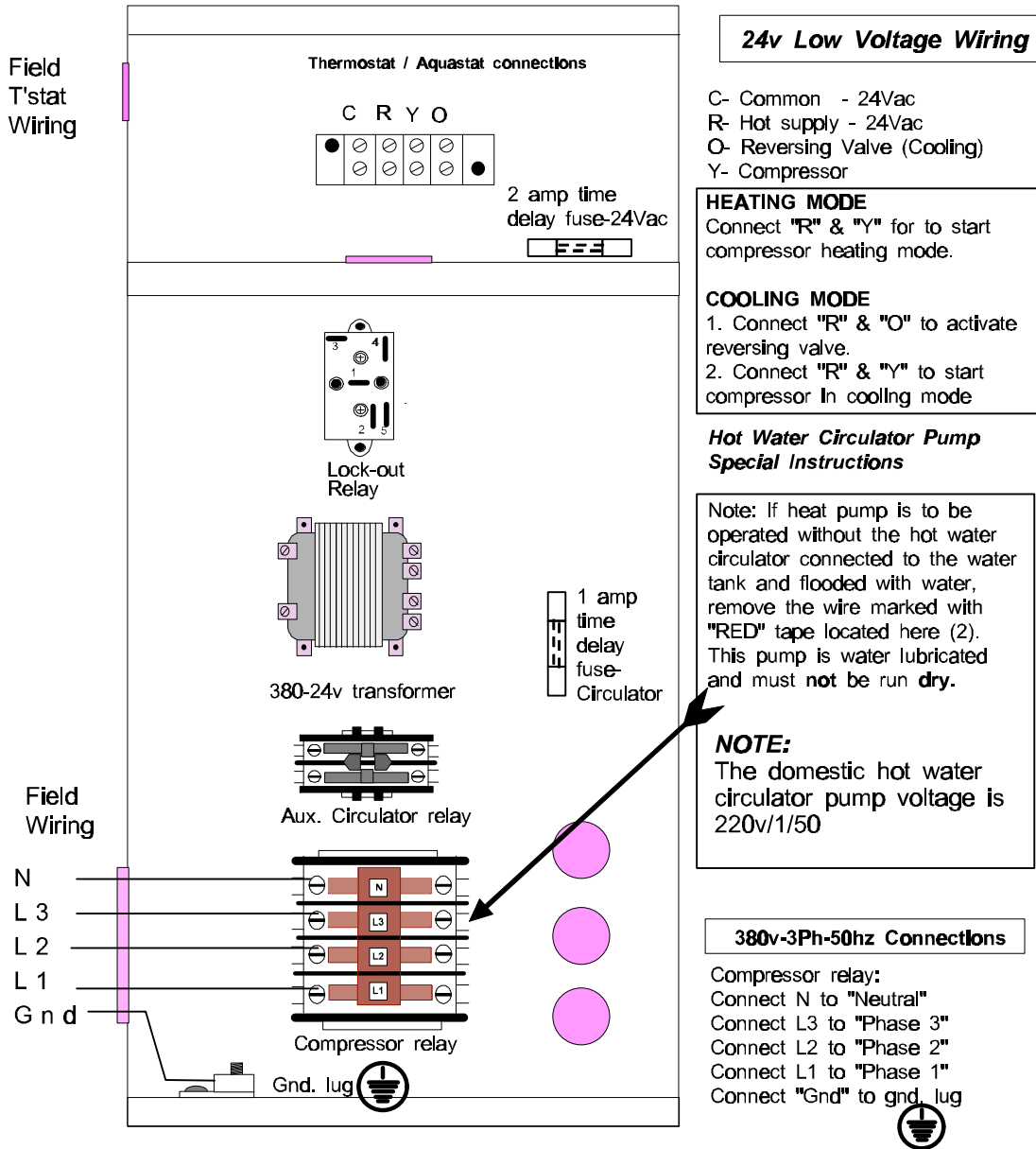

IMPORTANT NOTE FOR 3 PHASE "SCROLL" COMPRESSORS !!!

This unit is equipped with a scroll compressor which must rotate in the proper direction. After initial connection, start the compressor while observing the suction and discharge pressures with a refrigeration gauge set. If the compressor is not pumping - reverse supply conductors L1 and L2 and then recheck. (Reversing any two of the three input wires to a three phase motor will reverse the direction of the motor.)

L I M I T E D W A R R A N T Y

MARITIME GEOTHERMAL LTD. warrants that the heat pumps manufactured by it shall be free from defects in materials and workmanship for a period of (1) ONE YEAR after the date of installation or for a period of (1) ONE YEAR AND (60) SIXTY DAYS after the date of shipment, whichever occurs first. In addition MARITIME GEOTHERMAL LTD. warrants that the compressor shall be free of defects in materials and workmanship for an additional period of (48) FORTY-EIGHT MONTHS from said date.

MARITIME GEOTHERMAL LTD. shall, at it's option repair or replace any part or parts covered by this warranty which shall be returned to MARITIME GEOTHERMAL LTD., transportation charges prepaid, which, upon examination proves to be defective in materials or workmanship. Replacement or repaired parts and components are warranted only for the remaining portion of the original warranty period.

This warranty is subject to the following conditions:

1. The NORDIC® heat pump must be properly installed and maintained in accordance with MARITIME Geothermal LTD.'s installation and maintenance instructions.
2. The installer must complete the “**Installation Data Sheet**”, have it endorsed by the owner and return it to Maritime Geothermal Ltd. within 21 days after the installation of the unit.
3. It is the responsibility of the building or general contractor to supply temporary heat to the structure prior to occupancy. These heat pumps are designed to provide heat only to the completely finished and insulated structure. Start-up of the unit shall not be scheduled prior to completion of construction and final duct installation for validation of this warranty.
4. It is the customer's responsibility to supply the proper quantity and quality of water.

If the heat pump, manufactured by MARITIME GEOTHERMAL LTD. fails to conform to this warranty, MARITIME GEOTHERMAL LTD. 's sole and exclusive liability shall be, at it's option, to repair or replace any part or component which is returned by the customer during the applicable warranty period set forth above, provided that (1) MARITIME Geothermal LTD. is promptly notified in writing upon discovery by the customer that such part or component fails to conform to this warranty. (2) The customer returns such part or component to MARITIME GEOTHERMAL LTD., transportation charges prepaid, within (30) thirty days of failure, and (3) MARITIME GEOTHERMAL LTD. 's examination of such component shall disclose to it's satisfaction that such part or component fails to meet this warranty and the alleged defects were not caused by accident, misuse, neglect, alteration, improper installation, repair or improper testing.